



New Construction Windows

Architectural Flair. Personal Style. Unrivaled Quality.



Customized



Confident



Welcoming



Everlasting



Classic



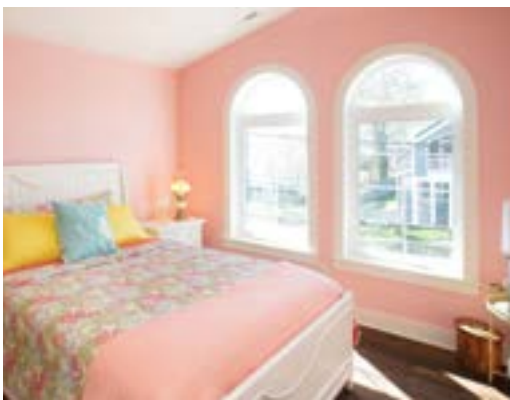





Table of Contents

Everyday Dreams	1
Everyday Innovation	3
Everyday Efficiency	5
Everyday Values	7
Everyday Performance	9
Everyday Complements	11
Geometric Windows	13
Picture Windows	15
Casement Windows	17
Sliding Windows	19
Bay and Bow Windows	21
Patio Doors	23
Everyday Options	
Colors	25
Simulated Divided Lites	27
Grids	27
Exterior Trim	28
Specialty Glass	29
Hardware	30
Screens	30
Everyday Accessories	31

Window Sizes and Detail Drawings

S-Series - Single-Hung	33
S-Series - Double-Hung	36
Geometric Windows	39
Picture & Transom Windows	41
Casement Windows	43
Awning Windows	48
Sliding Windows	49
Bay & Bow Windows	51
Patio Doors	55
Trim Casing Options	56

everyday Dreams

As a proudly family-owned and operated business for almost forty years, we know that turning dreams into reality demands a steady commitment to a personal vision. When we ventured into the window business, we set out to build a window that would stand for quality in every way. We've never wavered from that ideal. That's why we craft each one of our products from premium materials to your exact specifications. It's also why we use the most technologically advanced equipment available to make thermally efficient, exceptionally durable products. And it's why every employee, from myself, to our customer service representatives, to our sales force, takes your satisfaction to heart. You can count on us to help you with your order before, during and after installation.

We go the extra mile to ensure that our windows arrive at your distributor on time, on spec, and in perfect condition. Since our manufacturing process occurs almost entirely in our manufacturing facility—we even temper and laminate our own glass—we control the source. Our in-house production system enables us to custom-make every order to the highest standards while maintaining one of the fastest turnaround times in the industry.

We have been supplying materials to the homebuilding industry for a long time. My own experience working with building professionals represents a lifetime of acquired product knowledge and sensitivity to your needs. We know how to help you finish a successful project. One window at a time. One customer at a time. From idea to installation, we never lose sight of you.



A handwritten signature in black ink that reads 'David Barnes'.

David Barnes, President









everyday Innovation

We continually look to enhance our products as well as develop new ones to meet the changing needs of homeowners. Our state-of-the-art Research & Development and Training Center features a dedicated engineering and technical staff, and is home to our own certified test wall and on-site lab. Completed in early 2019, our training facility contains the latest technology aiding in on-going education for Viwinco employees and functions as a main focus for company tours. The R&D facility has enabled us to develop the next generation of windows—including our OceanView® impact-resistant line. Within the lab, our engineering staff studies the science of windows, gaining a keen view into what makes a window work. Since our engineers actively participate in the testing process, they often fine-tune our products to perfection, before bringing in third-party-certified technicians. Our S-Series™ product line scores exceptionally high in the American Architectural Manufacturers Association's (AAMA's) evaluations for design pressure (DP)—a rating that indicates a window's resistance to the effects of wind and other pressures. In fact, the vast majority of S-Series windows have received commercial as well as residential ratings. They're that strong! Our window frame profiles contain over five pounds more PVC than those manufactured by most of our competitors. The result: increased structural integrity, energy efficiency, and durability. The material's resilience is bolstered by SunShield® technology, a premium high-performance vinyl compound which contributes to industry-leading weather resistance, impact resistance, and color retention—as well as 41% better dimensional stability than the standard. What's more, PVC is inherently good for the environment; not only is it long lasting, it's 100% recyclable. Viwinco is proud to be located in a region renowned for quality craftsmanship. Our technology is cutting edge, but our values are basic: we listen to you, our customers, to identify new and better ways to serve you. For detailed information on our testing processes, including video footage, please visit www.Viwinco.com/about/product-testing

everyday Efficiency

A Higher Standard.

Viwinco Windows has been committed to optimal energy efficiency, a cleaner environment, and year-round home comfort ever since we first manufactured our standard high-performance glass package. We use this package as a matter of course in every window we produce.

- Double-strength Low-E glass
- 15/16" Double-strength glass
- Argon fill
- Low-conductance thermal spacer

Typical Window
3/4" single-strength,
insulated glass unit

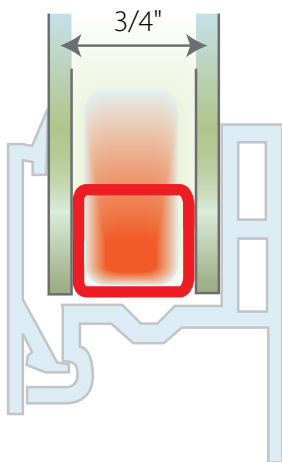

Viwinco S-Series™
15/16" double-strength,
insulated glass unit
with argon gas

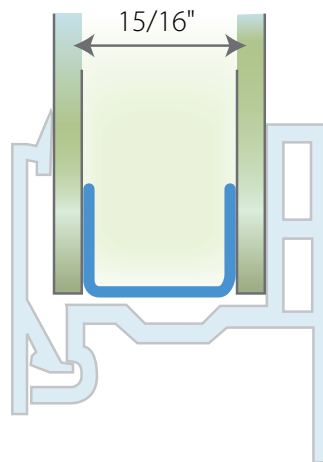



everyday Values

Traditional and stylish, our single- and double-hung windows are available in our premier S-Series line.

On **SINGLE-HUNG WINDOWS**, the bottom sash is operable and the top sash is fixed. Just raise the bottom sash for the ventilation you desire. Single-hungs are economical, easily serviceable, and allow for easy access to receive deliveries of drywall materials during construction. They also provide exceptional energy efficiency.

On **DOUBLE-HUNG WINDOWS**, both sashes are operable: the bottom sash lifts up and the top pulls down. Double-hungs offer beautiful sight lines and maximum ventilation.

S-Series single- and double-hung styles share the following features:

- A fully fusion-welded frame and sash for strength, durability, and low-maintenance
- A 15/16" double-strength insulated glass unit with Low-E, thermally efficient spacer, and argon gas fill for advanced performance
- Tilt-*n*-Lock patented technology
- A constant-force balance system made of 3/4" stainless steel for ease in opening and closing the window
- A sash interlock for added thermal efficiency and security
- Sill weatherstripping 1-3/8" high to fight drafts and water infiltration
- Equally-sized glass in both sashes for even sight lines
- Dual nite-vents

For window sizes and detail drawings, see pages 33-38

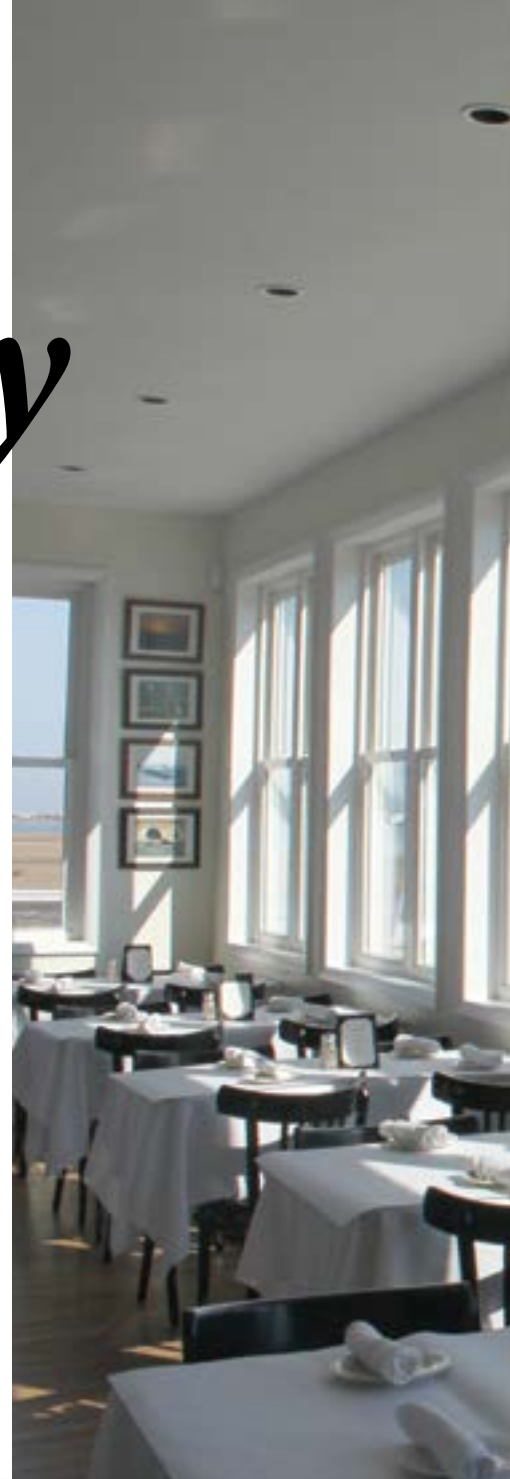



Tilt-*n*-Lock

HARDWARE

Standard on S-Series single- and double-hung windows

Exclusive Technology:

- One-handed operation
- Clean sight lines
- Easier cleaning



Locked Position

Sash is securely locked. Hidden tilt latches are housed in sash channel for added strength.



Unlocked Position

At the 150-degree position, the hidden tilt latches are engaged with the jamb, and the sash can be lifted.



Tilt-In Position

When the lever is moved to 180 degrees, the hidden tilt latches clear the jamb channel, allowing the user to easily tilt the sash inward.

everyday Performance

Viwinco S-Series™ Hung Windows

S-Series is our premier new construction line. Single- and double-hung units come standard with:

- Tilt-*n*-Lock hardware
- 15/16" Double-strength insulated glass unit
- Our high-performance glass package
- 3/4" Stainless steel constant force balance system

New Construction Standard Features:

- 1-1/4" Integral, pre-punched nailing fin contributes to trouble-free installation
- Chambered vinyl profiles add thermal efficiency and structural strength
- Beveled exterior for traditional craftsmanship look
- Equally sized glass in both sashes for balanced design
- S-Series single- and double-hung windows come standard with our patented reinforcement system with Tilt-*n*-Lock hardware, which provides strength where it's most needed, along the interlock. The reinforcement becomes the housing for the hardware which allows you to use the lock to tilt the sash in with just one hand. Tilt latches are not visible
- Sash interlock for added security and thermal efficiency
- 15/16" Double-strength insulated glass units with Low-E, low-conductance spacer and argon gas fill for excellent thermal performance
- 5-Degree true sloped sill directs water and debris away from the home
- Screen track secures screen to better block insects
- Integral J-channel saves time on exterior finishing
- Fully fusion-welded vinyl frame and sash for strength, durability and low-maintenance
- Dual nite-vents limit sash travel for ventilation
- Locking pivot bar secures sash to frame and stabilizes window for shipping
- Stainless steel, 3/4" constant-force balance eliminates sash drift and never needs adjustment
- Integral designer lift rails make sash operation easy and comfortable
- Fully welded sill dam with a mortised-in, replaceable weatherstripped leg increases strength and performance, while providing a clean, aesthetically appealing look
- Snap-in accessory expands J-channel to 1-1/4" to receive greater range of cladding thicknesses



Our S-Series single-hung window is engineered with two sashes for equal sight lines. It matches the look of our double-hung, but only the lower sash is operable.

For window sizes and detail drawings, see pages 33-38



everyday Complements

S-Series windows are available in many styles in addition to our traditional single- and double-hung. Enjoy the breathtaking atmosphere when you create a design of your own. Our structural mullions provide increased integrity between horizontally and/or vertically adjacent mounted windows—even at large sizes. See below for possible combinations, or browse through the following pages and imagine the possibilities.

Structural Mullions

Structural mullions attach directly to the rough opening, delivering great strength and stability to the finished installation. A window wall mull is available for casement and awning windows.

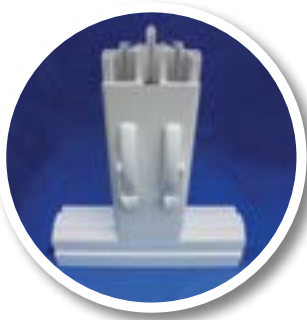

Integral Mullion
(continuous head and sill)
for mulling casement, picture,
and awning windows.



Structural Mullion
used to mull two or
more units together.
Interior view.

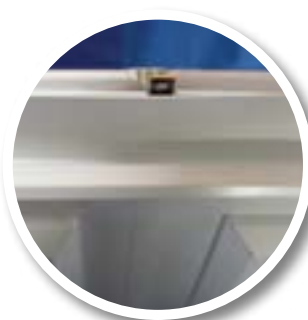

**Drip Cap
with Bracket**
to attach mullion
to rough opening.

Selected Mullered Combinations

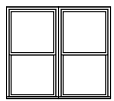

**Twin Single- or
Double-Hung**

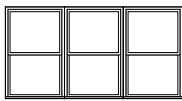

**Triple Single- or
Double-Hung**

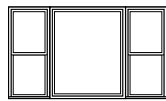

**Double-Hung/Picture/
Double-Hung or
Single-Hung/Picture/
Single-Hung**

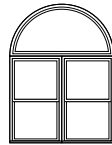

**Half-Round over
Twin Single- or
Double-Hung**

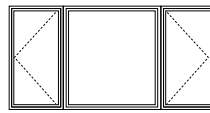

**Casement/Picture/
Casement**

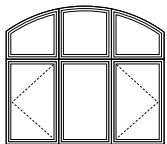

**Extended Arch
flanked by Arch Trapezoids
over Triple Picture or
Casement Window**



**Quarter-Round
over Picture
or Casement
Window**

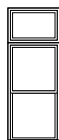

**Transom over
Single- or
Double-Hung**

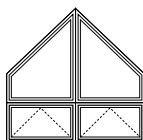

**Trapezoids over
Twin Picture or
Awning Window**

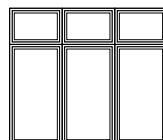

**Triple Transom over
Triple Picture
Window**









Geometric Windows

Build Castles in the Air.

We design windows of almost any geometric shape, and offer many different grid patterns to choose from. Use our geos alone, or pair them with different fixed or operable windows to achieve a truly spectacular, custom look in any room.

Geometric windows are available with all of our color and other options. See pages 25-30 for details.

Style Options

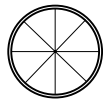

Circle

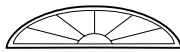

Elliptical



Half-Round



Extended-Arch

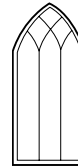

Gothic

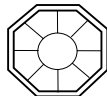

Octagon



Trapezoids

For additional shapes and grid options, see pages 39-40. Custom-made shapes and custom grids are also available.

Note: when geometric and picture windows are mullered together, sightlines will not be even.

Geometric Features

1. Integral J-channel saves time on exterior finishing
2. 15/16" Double-strength insulated glass unit with Low-E, Super Spacer®, and argon gas fill
3. Chambered vinyl profiles add thermal efficiency and structural strength
4. 1-1/4" Integral, pre-punched nailing fin contributes to a trouble-free installation
5. Fully fusion-welded sash and frame for strength, durability and low-maintenance

Interior colonial casing is available in 2-1/4" or 3-1/4". Only available in a white finish but it is paintable (image below shows the 3-1/4" option)



For the perfect finished look on any geometric window, choose Viwinco's bendable interior colonial casing and/or our factory-applied extension jambs, are color-matched to your window. We bend our jambs to the window shape.

For window sizes and detail drawings, see pages 39-40

Picture Windows

Infinite Combinations.

Picture windows let the light, and the view, pour in. Add a transom above for a particularly distinctive look, or enrich the atmosphere in any room by flanking with different styles.

Our most practical Windows. Pictures provide the highest energy efficiency solution to homeowners.

Available with all of our color and other options. See pages 25-30 for details.

Selected Combinations

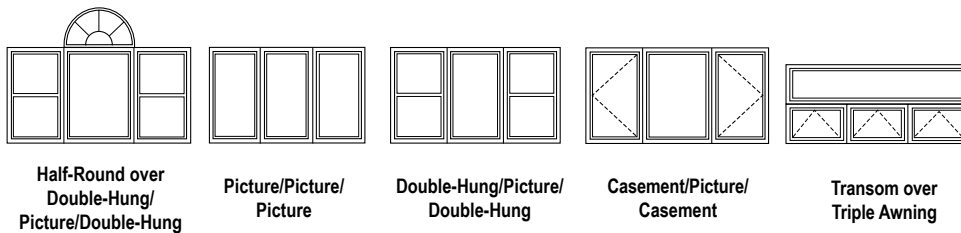

Picture Features

1. 15/16" Double-strength insulated glass unit with Low-E, low-conductance thermal spacer, and argon gas fill
2. Extruded glazing bead is mitered in the corners for a hand-crafted look
3. 1-1/4" Integral, pre-punched nailing fin contributes to a trouble-free installation
4. Fully fusion-welded frame for strength, durability and low-maintenance



For window sizes and detail drawings, see page 41-42







Casement and Awning Windows

Live from the Inside Out.

Our casement windows provide beautiful views and smooth operation. Use as the only window style in your home—or to complement other styles. Hinged at the left or the right depending on your needs, they swing open to the outside with a simple turn of the handle. Connected at the top, awning windows open outward and share many of the same features of casement windows. Multiple casements or awnings may be combined to create a window wall. Our structurally reinforced window wall mull maximizes visible glass between sashes and can be master framed up to 144" wide.



We also offer a Colonial Casement (left). It's designed to look like a double-hung window with the egress features of a casement window.

Fixed casements are available, too.

All our casement windows are available with our color and other options. See pages 25-30 for details.

Possible Combinations

Handing is viewed from the outside

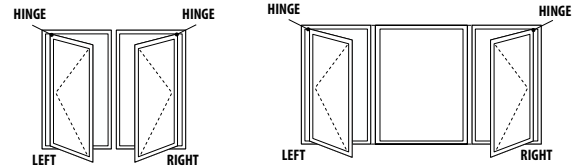

Twin Casement

Casement/Picture/Casement

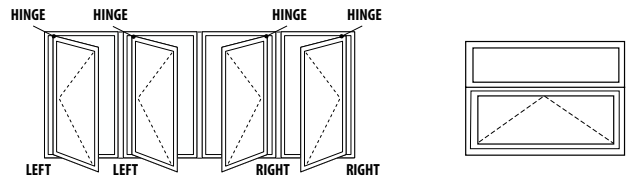

Combination Quad Casement

Transom over Awning (Hinged at top)

Casement and awning windows include many features available on our other S-Series styles, in addition to...

1. 15/16" Double-strength insulated glass unit with Low-E, low-conductance thermal spacer, and argon gas fill
2. Operating hinges that open 90 degrees to allow for easy cleaning. Stainless steel hardware is standard for added durability. Egress hardware is optional.
3. Multipoint lock for added security and snug sash closure
4. A folding handle design that tucks away for a clean, streamlined look. It means less interference with window treatments and easy removal of screens
5. Hardware attachment points that are reinforced for a lifetime of reliable operation

Triple weatherstripping for a tight seal against wind, water, sound, and airborne particles—as well as top thermal performance

Aluminum reinforcement in the sash and frame to provide structural integrity; fiberglass reinforcement optional.



For window sizes and detail drawings, see pages 43-48

Sliding Windows

Breathing Room.

Sliding windows, or *sliders*, are designed with space in mind: they won't obstruct passage or protrude into or outside of your living area. They're particularly convenient for window spaces that are wider than they are tall, and where access may be difficult. Since they open horizontally, they don't require the lifting force of single- or double-hung windows. Easy to operate, sliders also offer trouble-free maintenance: just lift out the sash, spray, and wipe.

- Positive latching with adjustable keeper and cam-style lock
- Interlock on sashes for energy conservation and durability

Sliding windows are available with all of our color and other options. See pages 25-30 for details.

Style Options

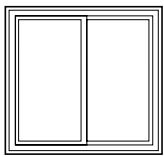

2-Lite
(1/2-1/2)

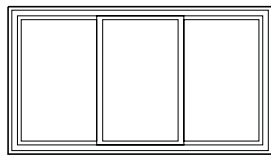

3-Lite
(1/3-1/3-1/3)

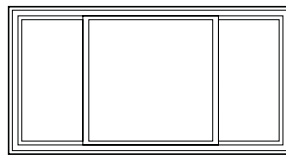

3-Lite
(1/4-1/2-1/4)

Our 3-lite sliders feature a fixed center lite and venting end lites

Slider Features

1. Cam-style lock with adjustable keeper for reliable alignment and positive locking
2. Sashes interlock for thermal performance, alignment, and strength
3. 15/16" Double-strength insulated glass unit Low-E, low-conductance thermal spacer, and argon gas fill
4. Sash track with monorail-design slider pad provides smooth glide operation
5. Both sashes operate for ventilation. Both sashes lift out for safe cleaning from the inside
6. Extruded designer pull rails (on both sashes) make sash operation easy and comfortable
7. Fully fusion-welded frame and sash for structural strength and durability



For window sizes and detail drawings, see page 49-50







Bay and Bow Windows

Create an Everyday Escape.

Bay and bow windows have a transformative effect on a home. Viewed from outside or in, they provide a unique architectural element, making a home seem larger and more welcoming. Enjoy gazing at your surroundings from your windowseat.

- Fully fusion-welded vinyl frames for strength, durability and low-maintenance
- Chain suspension system attaches directly to frame of the house for structurally sound installation
- Tie rods uniting the headboard and seat board provide stability
- Headboard and seat board manufactured from insulated marine-grade plywood with birch veneer. Paintable or stainable to match your décor (oak veneer headboard and seat board also available as an upgrade)

Bays and Bows are available with all of our color and other options. See pages 25-30 for details.

Possible Combinations

Bay Windows

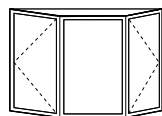

30° Bay
Casement/Picture/Casement

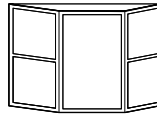

30° Bay
Double-Hung/Picture/Double-Hung

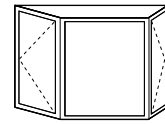

45° Bay
Casement/Picture/Casement

10° Bow Windows

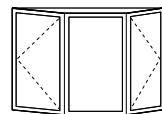

3-Lite
Casement/Picture/Casement

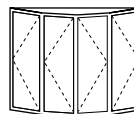

4-Lite
Casement/Casement/
Casement/Casement

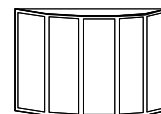

5-Lite
Picture/Picture/Picture/
Picture/Picture



Design your own bay or bow unit with single-hung, double-hung, casement or picture styles. See individual size charts for dimensions, or order a custom size. Custom jamb depths and projections are available.

For window sizes and detail drawings, see pages 51-52

Be the Center of Every Season.

A home's patio doors get lots of action. In addition to being highly functional, they're often the focal point of a room. Our patio doors are designed for easy indoor/outdoor access, thermal efficiency, reliable operation, and everyday elegance.

Patio Door Options

- 2-Lite, 3-lite, and 4-lite patio doors come standard with a vinyl sill.
- Knock down assembly option available for 2-lite, 3-lite, and 4-lite patio doors
- Blinds between glass available on select sizes, see page 54 for size details

Patio Doors are available with all of our color and other options. See pages 25-30 for details.

Patio Door Features

1. Head and jamb track covers for a finished appearance
2. Snap-in J-channel accessory is available to allow for a 3/4" or a 1-1/4" J-channel pocket for siding with a brick mold look on the exterior
3. 1" Tempered, double-strength insulated glass unit with Low-E, low-conductance thermal spacer, and argon gas fill for strength and thermal efficiency
4. Extruded glazing bead is mitered in the corners for a hand-crafted look
5. Precision-cut and fusion-welded frame creates a powerfully-built sliding patio door
6. Independent screen track keeps heavy-duty "Moose" screen in place during travel
7. Threshold cover keeps out dirt, grass and leaves
8. Weep hole system is located beneath the screen track



Style Options

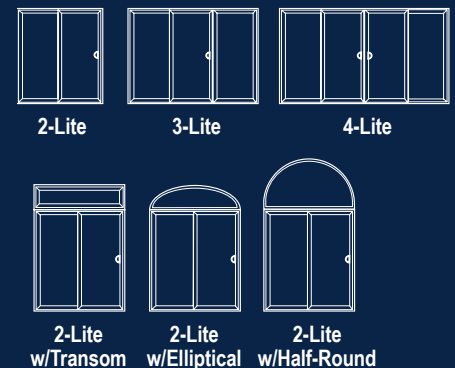

For window sizes and detail drawings, see pages 53-55



Patio Door Handing Options

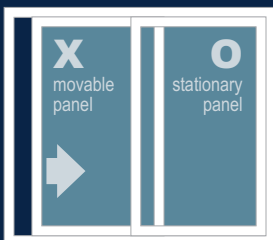

Left-Hand Operation
Viewed from outside

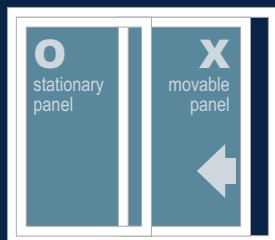

Right-Hand Operation
Viewed from outside

4" Stiles and a slim frame allow you to make the most of your view. Available grid patterns include colonial and prairie, in flat or deluxe styles. SDLs also available.

Handle Options



Our patio doors have a 2-point locking system made from heavy-duty components to assure positive locking.

Locks may be keyed or non-keyed.

D-shaped handles are standard on the inside of the house. Shown (left) in Brushed Nickel.





everyday Options

Windows and doors are one of the most eye-catching aspects of a home, and adding color is one of the easiest ways to add personality. Viwinco's exterior laminates do more than bring character to your home, however, they are the most robust and enduring you can find. Engineered to outperform some of the harshest conditions, our exterior laminates are proven to withstand the test of time while maintaining the bold colors you want. Did we mention our laminates also provide exceptional thermal performance? Our premium laminates are comprised of multiple thin layers that result in a finish that is highly resistant to harmful ultraviolet light and salty air (ideal for coastal applications). Durable, efficient, and bold, our exterior colored laminates are the perfect solution to adding personalization to any project.

Traditional Solid Extrusions:

S-Series windows and patio doors are available in all our solid extrusions



White

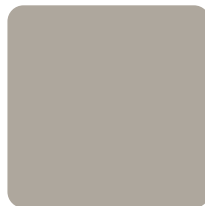

Tan



Clay

VIWINCO COLORS Available with white interior only

Offered on all S-Series windows and patio doors.



Bronze

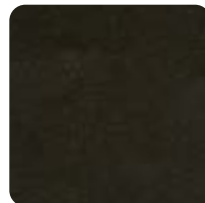

Midnight Black

- ▶ Triple-layer construction for exceptional durability
- ▶ More robust than paint: won't chip, crack, or fade
- ▶ Heat-reflective technology
- ▶ Impervious to the damaging effects of moisture and salt; ideal for coastal regions



Twin double-hung with simulated divided lites in top sash, interior view. **Inset:** Exterior view of simulated divided lites

Simulated Divided Lites

Achieve the classic look of authentic divided lites while enhancing your window's energy efficiency.

- Great for historic restorations
- SDLs permanently adhere to the inside and outside of the glass
- SDLs are offered in all of our solid extrusions and exterior colors



Simulated Divided Lites and Deluxe Grids may be laminated to match your window. Shown above in Midnight black.

Grids

Grids add definition to your window and character to your home. Sealed between the glass for easy cleaning, they are available in two styles—flat internal or deluxe internal.

Windows with an exterior laminate are available with color-matched deluxe grids.

Patterns:

Colonial, Prairie, Double Prairie, Diamond (flat internal only), Queen Anne, Valance, or specialty designs.

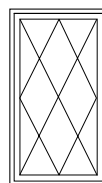

Diamond

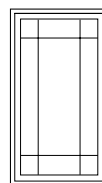

Prairie

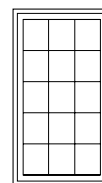

Colonial



Deluxe top,
Standard bottom



3-1/2" Flat casing picture frame in tan



2-1/4" Brick Mold with Bullnose Sill

Exterior Trim and Brick Molding

Accentuate your style and significantly reduce window installation and finishing time with our maintenance-free, highly durable PVC trim options.

Available in any of our exterior colors, our 3-1/2" flat casing and 2-1/4" brick molding are fully welded, factory applied, and come with an extruded J-channel pocket. For installations where a J-channel pocket is not required, pocket filler is available.

Both exterior trim options are offered with either a picture-frame or bullnose sill.

For detail drawings, see page 56



Casement window with obscure glass

Specialty Glass

Options for glazing include obscure, gray tint, and bronze tint. Tempered glass (not shown) is available for extra safety and is commonly used in high-traffic areas.

Choice of gray or bronze to reduce solar heat gain and glare; obscure glass to increase privacy.



Bronze-tinted



Gray-tinted



Obscure

Tilt-n-Lock Hardware is standard on S-Series double- and single-hung windows.

In addition to the structural benefits described on pages 7-10, Tilt-n-Lock provides a clean, uncluttered view. By eliminating tilt latches we've rid the window of unnecessary crevices that attract dust. The one-handed system allows you to tilt the window in with one hand and hold your cleaning supplies in the other. When you're done cleaning, simply push the window shut; there are no tilt latches to re-engage.



White
(available only on white hung windows)



Tan
(available only on tan hung windows)



Clay
(available only on clay hung windows)



Brushed Nickel
(optional on hung windows of any color)

Casement Hardware

All casements and awnings come standard with stainless steel hardware for added strength and durability



Stainless steel operator, hinge track, and hinge arm

Window Operating Control Device Locks

We offer window operating control devices (WOCD) when required by code on our hung and casement products.



WOCDs for single- and double-hung windows



WOCDs for casement windows

Heavy-Duty Extruded Screens

Our heavy-duty, extruded screen frames are designed for optimal performance. Reinforced on all four corners, the aluminum frame is resilient and resistant to rust. The heavy-duty frame will keep it from warping or bowing. Available in full or half-sizes. Double-hung windows come standard with full screens and single-hung windows come standard with half screens.



Extruded screens are built to last the life of your window. Pull rails are located on all four sides, there are no pull tabs to obscure your view

8 5/2

3. VUC L-84T FEED K 112 L16. JUMP TO PAPER 06.



Tilt-n-lock
ENERGY STAR
U-Value: 0.25
R-Value: 4.00

Tilt-n-lock
ENERGY STAR
U-Value: 0.25
R-Value: 4.00

Tilt-n-lock
ENERGY STAR
U-Value: 0.25
R-Value: 4.00



everyday Accessories

Designed to make installation a breeze.

Viwinco engineers its windows and patio doors to be easier for the homeowner or contractor to install. To further aid in the installation process, we also offer accessory pieces.

- Snap-in accessories
- Muller units
- Jamb extensions

Snap-in Accessories

- Snap-in brick molding on patio doors can provide a 3/4" or 1-1/4" J-channel
- Similar snap-in brick mold available on windows for a 1-1/4" J-channel for exterior finishes such as insulated siding
- J-channel pocket filler available on windows for use in fiber cement or masonry applications

Snap-in J-channel

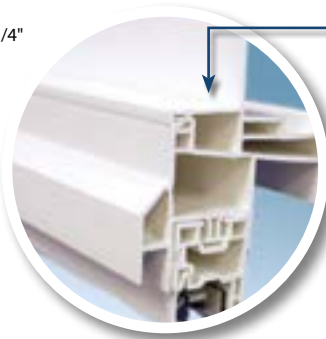
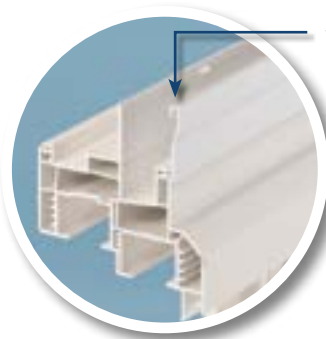





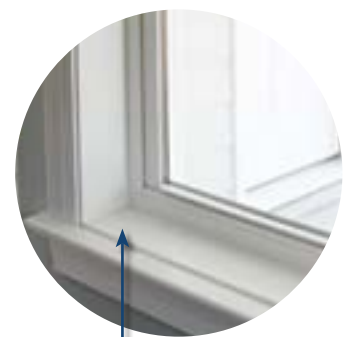



































































Extension Jamb

- Factory applied
- Color-matched to your window
- Available sizes: 4-5/8" and 6-5/8".
We can also accommodate requests for jamb to be made any size smaller than 6-5/8"



Jamb
Extensions

Rough Opening				Single-Hung															
				20"	24"	28"	32"	36"	40"	44"	48"	52"							
Unit Size				19½"	23½"	27½"	31½"	35½"	39½"	43½"	47½"	51½"							
Sash Opening				13⅞"	17⅞"	21⅞"	25⅞"	29⅞"	33⅞"	37⅞"	41⅞"	45⅞"							
Visible Glass-Sash				11⅜"	15⅜"	19⅜"	23⅜"	27⅜"	31⅜"	35⅜"	39⅜"	43⅜"							
36"	35½"										SH2036	SH2436	SH2836	SH3236	SH3636	SH4036	SH4436	SH4836	SH5236
	44"	43½"										SH2044	SH2444	SH2844	SH3244	SH3644	SH4044	SH4444	SH4844
48"	47½"										SH2048	SH2448	SH2848	SH3248	SH3648	SH4048	SH4448	SH4848	SH5248
	52"	51½"										SH2052	SH2452	SH2852	SH3252	SH3652	SH4052	SH4452	SH4852
60"	59½"										SH2060	SH2460	SH2860	SH3260	SH3660	SH4060	SH4460	SH4860	SH5260
	66"	65½"										SH2066	SH2466	SH2866	SH3266	SH3666	SH4066	SH4466	SH4866
72"	71½"										SH2072	SH2472	SH2872	SH3272	SH3672	SH4072	SH4472	SH4872	SH5272
	80"	79½"										SH2080	SH2480	SH2880	SH3280	SH3680	SH4080	SH4480	SH4880

Single-Hung Vertical Detail

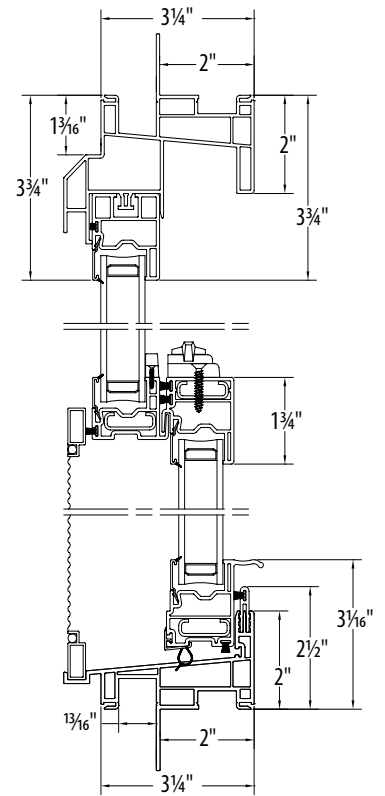

Callout sizes are expressed in inches and equal rough opening.

Single-hung windows have an interior frame depth of 2"; exterior projection of the frame is 1-3/16" from the nail fin.

When mulling a unit to a single-hung, overall rough opening is not affected by the mullion.

66" Tall windows are the maximum size available as oriels. Oriels are windows having 60% to 40% sash height proportions with the larger sash on top.

Reverse oriels have the smaller sash on top.

● Meets egress of:

- Clear opening area ≥ 5.7 sq. ft.
- Clear opening width ≥ 20"
- Clear opening height ≥ 24"

● All windows that can meet egress with egress hardware will automatically be manufactured to meet egress.

























● 2U1R2C: Mullied two-unit (one row, two columns).

● 2U2R1C: Mullied two-unit (two rows, one column).

■ Meets DP50 rating. Specify DP50 when ordering.

For the latest testing data, contact Customer Service or visit our website at www.viwinco.com

Single-Hung with Transom 2U2R1C[®] Vertical Detail

Rough Opening		Twin Single-Hung 2U1R2C [®]		
		56"	64"	72"
Unit Size		55½"	63½"	71½"
Sash Opening		21⅞"	25⅞"	29⅞"
Visible Glass-Sash		19⅜"	23⅜"	27⅜"
36"	35½"			
	13⅞"	SHSH5636	SHSH6436	SHSH7236
44"	43½"			
	17⅞"	SHSH5644	SHSH6444	SHSH7244
48"	47½"			
	19⅞"	SHSH5648	SHSH6448	SHSH7248
52"	51½"			
	21⅞"	SHSH5652	SHSH6452	SHSH7252
60"	59½"			
	25⅞"	SHSH5660	SHSH6460	SHSH7260
66"	65½"			
	28⅞"	SHSH5666	SHSH6466	SHSH7266
72"	71½"			
	31⅞"	SHSH5672	SHSH6472	SHSH7272
80"	79½"			
	35⅞"	SHSH5680	SHSH6480	SHSH7280

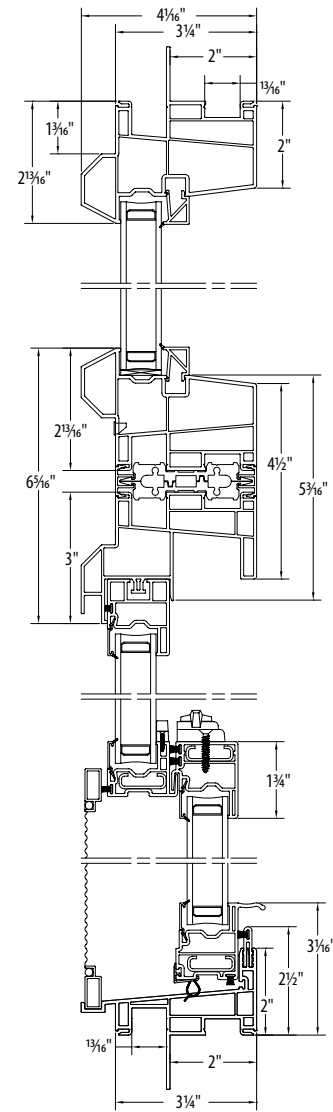

For transom sizes, see page 42

Twin Single-Hung 2U1R2C[®] Horizontal Detail

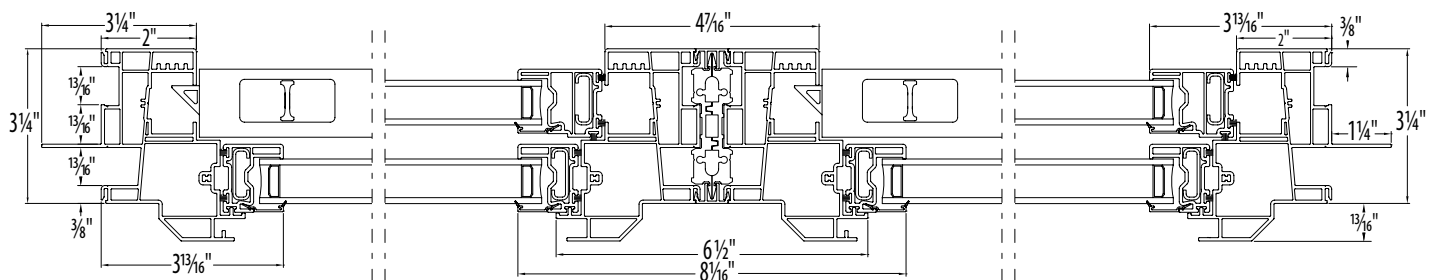

Rough Opening	Triple Single-Hung 3U1R3C [®]		
	84"	96"	108"
Unit Size	84"	96"	108"
Sash Opening	21 ³ / ₁₆ "	25 ³ / ₁₆ "	29 ³ / ₁₆ "
Visible Glass-Upper Sash	19 ³ / ₄ "	23 ³ / ₄ "	27 ³ / ₄ "
Visible Glass-Lower Sash	19 ³ / ₄ "	23 ³ / ₄ "	27 ³ / ₄ "
36"	35 ¹ / ₂ "	13 ¹ / ₄ "	13 ¹ / ₄ "
	SHSHSH8436	SHSHSH9636	SHSHSH10836
44"	43 ¹ / ₂ "	17 ¹ / ₄ "	17 ¹ / ₄ "
	SHSHSH8444	SHSHSH9644	SHSHSH10844
48"	47 ¹ / ₂ "	19 ¹ / ₄ "	19 ¹ / ₄ "
	SHSHSH8448	SHSHSH9648	SHSHSH10848
52"	51 ¹ / ₂ "	21 ¹ / ₄ "	21 ¹ / ₄ "
	SHSHSH8452	SHSHSH9652	SHSHSH10852
60"	59 ¹ / ₂ "	25 ¹ / ₄ "	25 ¹ / ₄ "
	SHSHSH8460	SHSHSH9660	SHSHSH10860
66"	65 ¹ / ₂ "	28 ¹ / ₄ "	28 ¹ / ₄ "
	SHSHSH8466	SHSHSH9666	SHSHSH10866
72"	71 ¹ / ₂ "	31 ¹ / ₄ "	31 ¹ / ₄ "
	SHSHSH8472	SHSHSH9672	SHSHSH10872
80"	79 ¹ / ₂ "	35 ¹ / ₄ "	35 ¹ / ₄ "
	SHSHSH8480	SHSHSH9680	SHSHSH10880

Rough Opening	Single-Hung/Picture/Single-Hung 3U1R3C [®]			
	80"	92"	104"	124"
Unit Size	79 ¹ / ₂ "	23 ¹ / ₂ "	27 ¹ / ₂ "	31 ¹ / ₂ "
SHPXSH Unit Configuration	20-40-20	24-44-24	28-48-28	32-60-32
Sash Opening	13 ⁷ / ₁₆ "	17 ⁷ / ₁₆ "	21 ⁷ / ₁₆ "	25 ⁷ / ₁₆ "
Visible Glass-Sash	11 ¹³ / ₁₆ "	15 ¹³ / ₁₆ "	19 ¹³ / ₁₆ "	23 ¹³ / ₁₆ "
Visible Glass-Fixed Center	33 ³ / ₄ "	37 ³ / ₄ "	41 ³ / ₄ "	23 ³ / ₄ "
36"	35 ¹ / ₂ "	13 ¹ / ₄ "	13 ¹ / ₄ "	29 ³ / ₄ "
	SHPXSH8036	SHPXSH9236	SHPXSH10436	SHPXSH12436
48"	47 ¹ / ₂ "	19 ¹ / ₄ "	19 ¹ / ₄ "	41 ³ / ₄ "
	SHPXSH8048	SHPXSH9248	SHPXSH10448	SHPXSH12448
60"	59 ¹ / ₂ "	25 ¹ / ₄ "	25 ¹ / ₄ "	53 ³ / ₄ "
	SHPXSH8060	SHPXSH9260	SHPXSH10460	SHPXSH12460

Callout sizes are expressed in inches and equal rough opening. Single-hung windows have an interior frame depth of 2" and an exterior projection of 1-3/16" from the nail fin. When mulling a unit to a single-hung, overall rough opening is not affected by the mullion. 66" Tall windows are the maximum size available as oriels. Oriels are windows having 60% to 40% sash height proportions with the larger sash on top. Reverse oriels have the smaller sash on top.

- 1 Meets egress of: Clear opening area ≥ 5.7 sq. ft. Clear opening width ≥ 20" Clear opening height ≥ 24"
- 2 3U1R3C: Mullied three-unit (one row, three columns).
- 3 All windows that can meet egress with egress hardware will automatically be manufactured to meet egress.
- 4 Meets DP50 rating. Specify DP50 when ordering.





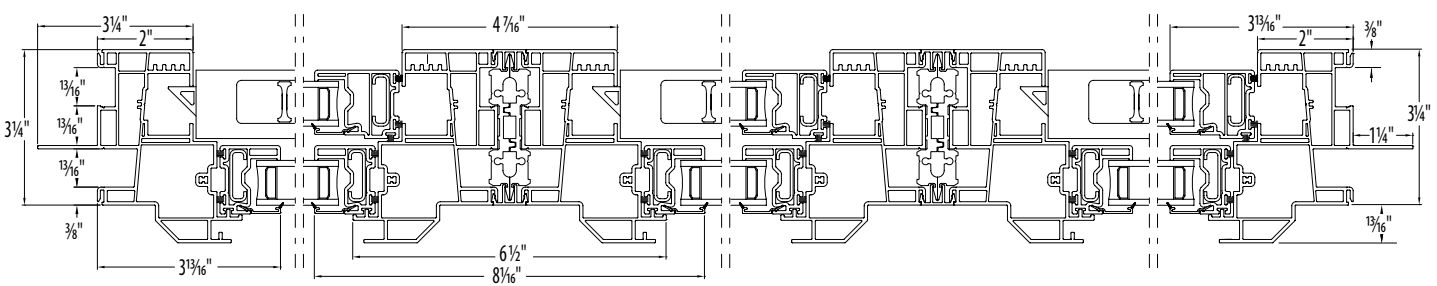



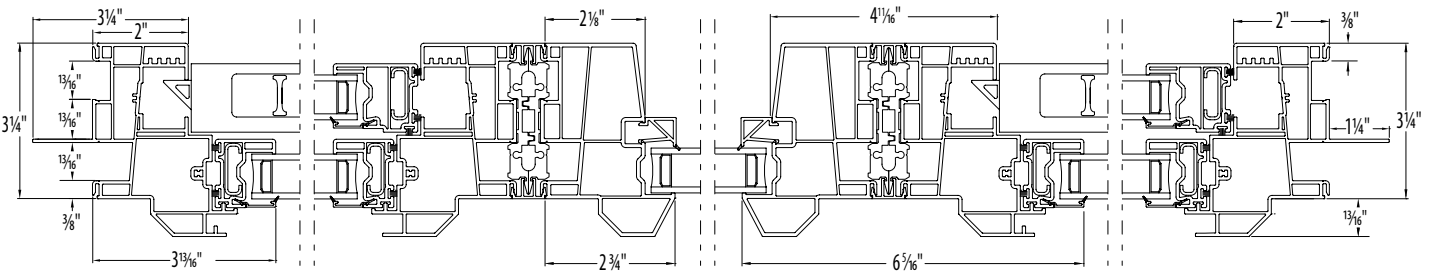







































































For the latest testing data, contact Customer Service or visit our website at www.Viwinco.com

Triple Single-Hung 3U1R3C[®] Horizontal Detail



Single-Hung/Picture/Single-Hung 3U1R3C[®] Horizontal Detail



Rough Opening		Double-Hung								
		20"	24"	28"	32"	36"	40"	44"	48"	52"
Unit Size		19½"	23½"	27½"	31½"	35½"	39½"	43½"	47½"	51½"
Sash Opening		13⅞"	17⅞"	21⅞"	25⅞"	29⅞"	33⅞"	37⅞"	41⅞"	45⅞"
Visible Glass-Upper Sash		11¾"	15¾"	19¾"	23¾"	27¾"	31¾"	35¾"	39¾"	43¾"
Visible Glass-Lower Sash		11¾"	15¾"	19¾"	23¾"	27¾"	31¾"	35¾"	39¾"	43¾"
36"	35½"	 DH2036	 DH2436	 DH2836	 DH3236	 DH3636	 DH4036	 DH4436	 DH4836	 DH5236
	13¼"									
44"	43½"	 DH2044	 DH2444	 DH2844	 DH3244	 DH3644	 DH4044	 DH4444	 DH4844	 DH5244
	17⅞"									
48"	47½"	 DH2048	 DH2448	 DH2848	 DH3248	 DH3648	 DH4048	 DH4448	 DH4848	 DH5248
	19⅞"									
52"	51½"	 DH2052	 DH2452	 DH2852	 DH3252	 DH3652	 DH4052	 DH4452	 DH4852	 DH5252
	21⅞"									
60"	59½"	 DH2060	 DH2460	 DH2860	 DH3260	 DH3660	 DH4060 ②	 DH4460 ②	 DH4860 ②	 DH5260 ②
	25⅞"									
62"	61½"	 DH2062	 DH2462	 DH2862	 DH3262	 DH3662	 DH4062 ②	 DH4462 ①	 DH4862 ①	 DH5262 ①
	26⅞"									
66"	65½"	 DH2066	 DH2466	 DH2866	 DH3266	 DH3666 ②	 DH4066 ①	 DH4466 ①	 DH4866 ①	 DH5266 ①
	28⅞"									
72"	71½"	 DH2072	 DH2472	 DH2872	 DH3272	 DH3672 ②	 DH4072 ①	 DH4472 ①	 DH4872 ①	 DH5272 ①
	31⅞"									
80"	79½"	 DH2080	 DH2480	 DH2880	 DH3280 ①	 DH3680 ①	 DH4080 ①	 DH4480 ①	 DH4880 ①	 DH5280 ①
	35⅞"									

Double-Hung Vertical Detail

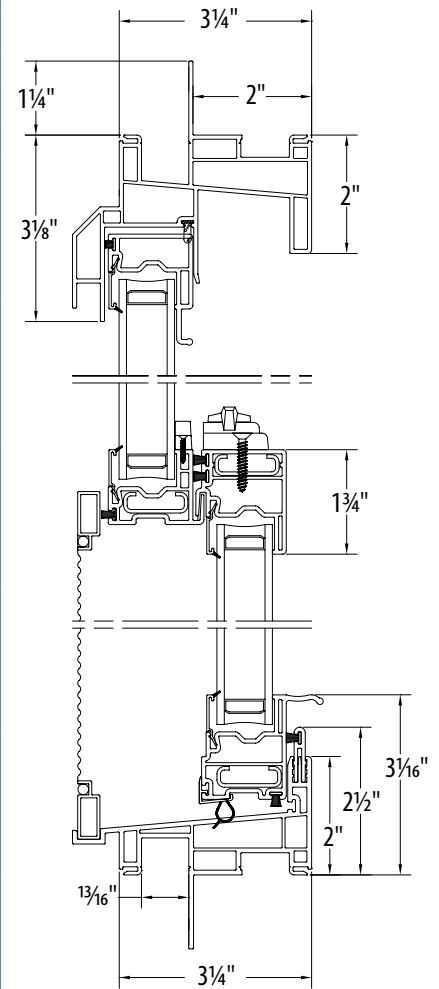

Callout sizes are expressed in inches and equal rough opening.

Double-hung windows have an interior frame depth of 2"; exterior projection of the frame is 1-3/16" from the nail fin.

When mulling a unit to a double-hung, overall rough opening is not affected by the mullion.

66" Tall windows are the maximum size available as oriels. Oriels are windows having 60% to 40% sash height proportions with the larger sash on top.

Reverse oriels have the smaller sash on top.

- ① Meets egress of:
Clear opening area ≥ 5.7 sq. ft.
Clear opening width ≥ 20"
Clear opening height ≥ 24"

- ② All windows that can meet egress with egress hardware will automatically be manufactured to meet egress.

- ③ Meets DP50 rating. Specify DP50 when ordering.

For the latest testing data, contact Customer Service or visit our website at www.Viwinco.com

Rough Opening	Twin Double-Hung 2U1R2C [®]			
	56"	64"	72"	
Unit Size	55½"	63½"	71½"	
Sash Opening	21¾"	25¾"	29¾"	
Visible Glass-Upper Sash	19¾"	23¾"	27¾"	
Visible Glass-Lower Sash	19¾"	23¾"	27¾"	
36"	35½"	DHDH5636	DHDH6436	DHDH7236
	13¼"			
44"	43½"	DHDH5644	DHDH6444	DHDH7244
	17¼"			
48"	47½"	DHDH5648	DHDH6448	DHDH7248
	19¼"			
52"	51½"	DHDH5652	DHDH6452	DHDH7252
	21¼"			
60"	59½"	DHDH5660	DHDH6460	DHDH7260
	25¼"			
62"	61½"	DHDH5662	DHDH6462	DHDH7262
	26¼"			
66"	65½"	DHDH5666	DHDH6466	DHDH7266
	28¼"			
72"	71½"	DHDH5672	DHDH6472	DHDH7272
	31¼"			
80"	79½"	DHDH5680	DHDH6480	DHDH7280
	35¼"			

Rough Opening	Triple Double-Hung 3U1R3C [®]			
	84"	96"	108"	
Unit Size	83½"	95½"	107½"	
Sash Opening	21¾"	25¾"	29¾"	
Visible Glass-Upper Sash	19¾"	23¾"	27¾"	
Visible Glass-Lower Sash	19¾"	23¾"	27¾"	
36"	35½"	DHDHDH8436	DHDHDH9636	DHDHDH10836
	13¼"			
44"	43½"	DHDHDH8444	DHDHDH9644	DHDHDH10844
	17¼"			
48"	47½"	DHDHDH8448	DHDHDH9648	DHDHDH10848
	19¼"			
52"	51½"	DHDHDH8452	DHDHDH9652	DHDHDH10852
	21¼"			
60"	59½"	DHDHDH8460	DHDHDH9660	DHDHDH10860
	25¼"			
62"	61½"	DHDHDH8462	DHDHDH9662	DHDHDH10862
	26¼"			
66"	65½"	DHDHDH8466	DHDHDH9666	DHDHDH10866
	28¼"			
72"	71½"	DHDHDH8472	DHDHDH9672	DHDHDH10872
	31¼"			
80"	79½"	DHDHDH8480	DHDHDH9680	DHDHDH10880
	35¼"			

Twin Double-Hung
2U1R2C[®]
Horizontal Detail

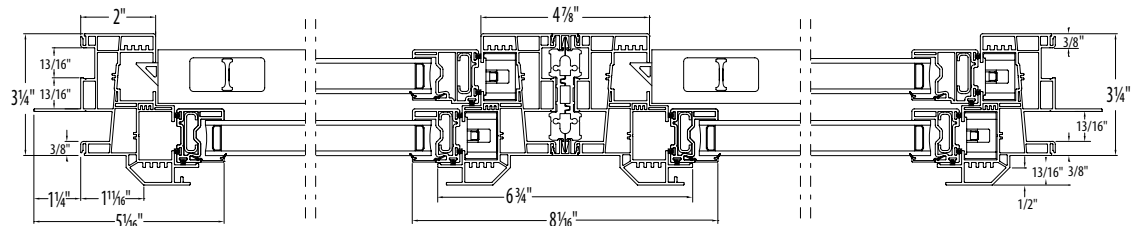

Triple Double-Hung
3U1R3C[®]
Horizontal Detail

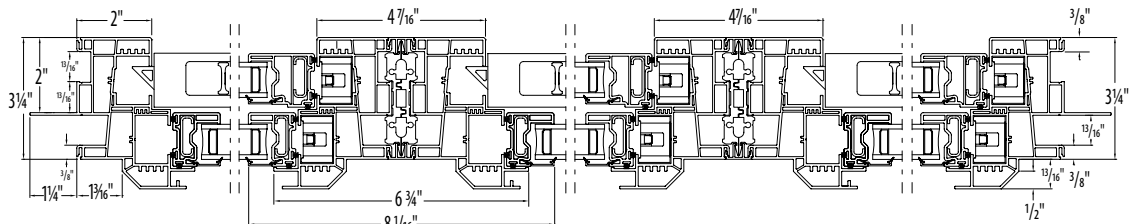

Rough Opening		Double-Hung /Picture/Double-Hung 3U1R3C [®]			
		80"	92"	104"	124"
Unit Size		79½"	91½"	103½"	123½"
DHPXDH Unit Configuration		20-40-20	24-44-24	28-48-28	32-60-32
Sash Opening		13⅜"	17⅜"	21⅜"	25⅜"
Visible Glass-Upper Sash		11¾"	15¾"	19¾"	23¾"
Visible Glass-Upper Center		33¾"	37¾"	41¾"	53¾"
Visible Glass-Fixed Lower		11¾"	15¾"	19¾"	23¾"
36"	35½"				
	—	13⅜"	13⅜"	29¾"	DHPXDH8036 DHPXDH9236 DHPXDH10436 DHPXDH12436
48"	47½"				
	—	19⅞"	19⅞"	41¾"	DHPXDH8048 DHPXDH9248 DHPXDH10448 DHPXDH12448
60"	59½"				
	—	25⅞"	25⅞"	53¾"	DHPXDH8060 DHPXDH9260 DHPXDH10460 DHPXDH12460

Double-Hung with Transom 2U2R1C[®]
Vertical Detail

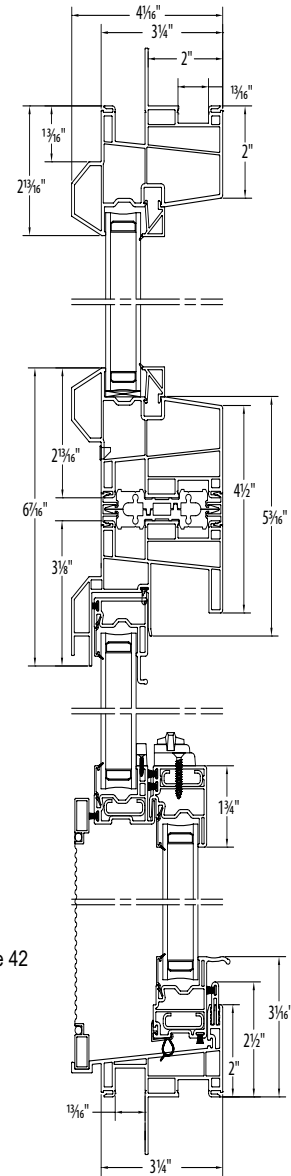

For transom sizes, see page 42

Double-Hung/Picture/Double-Hung 3U1R3C[®] Horizontal Detail

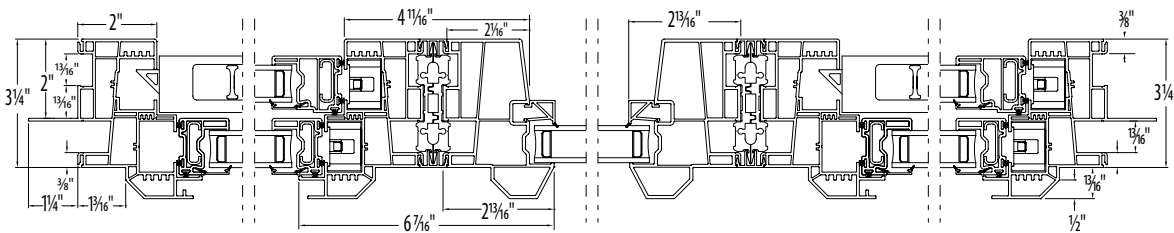

Callout sizes are expressed in inches and equal rough opening.
 Double-hung windows have an interior frame depth of 2"; exterior projection of the frame is 1-3/16" from the nail fin.
 When mulling a unit to a double-hung, overall rough opening is not affected by the mullion.
 66" Tall windows are the maximum size available as oriels.
 Oriels are windows having 60% to 40% sash height proportions with the larger sash on top. Reverse oriels have the smaller sash on top.

- Meets egress of:
 Clear opening area ≥ 5.7 sq. ft.
 Clear opening width ≥ 20"
 Clear opening height ≥ 24"

- All windows that can meet egress with egress hardware will automatically be manufactured to meet egress.
 - 2U1R2C: Mullied two-unit (one row, two columns).
 - 3U1R3C: Mullied three-unit (one row, three columns).
 - 2U2R1C: Mullied three-unit (one row, three columns).
 - Meets DP50 rating. Specify DP50 when ordering.
- For the latest testing data, contact Customer Service or visit our website at www.Viwinco.com

Extended Arch and Eyebrow											
Chord Height	4 ³ / ₈ "	5 ¹ / ₈ "	5 ⁷ / ₈ "	6 ⁵ / ₈ "	7 ¹ / ₁₆ "	8 ¹ / ₈ "	9"	11 ¹ / ₄ "	13 ¹ / ₂ "	17 ¹³ / ₁₆ "	
Rough Opening	24"	28"	32"	36"	40"	44"	48"	60"	72"	96"	
Unit Width	23 ¹ / ₂ "	27 ¹ / ₂ "	31 ¹ / ₂ "	35 ¹ / ₂ "	39 ¹ / ₂ "	43 ¹ / ₂ "	47 ¹ / ₂ "	59 ¹ / ₂ "	71 ¹ / ₂ "	95 ¹ / ₂ "	
Series	Shoulder Height (NET)										
	Eyebrow										
A	7 ¹ / ₈ "										
B	19 ¹ / ₈ "	Extended Arch									
	C	31 ¹ / ₈ "									
	D	39 ¹ / ₈ "									
	E	43 ¹ / ₈ "									
	F	47 ¹ / ₈ "									
	G	55 ¹ / ₈ "									
	H	61 ¹ / ₈ "									
	I	67 ¹ / ₈ "									
	J	79 ¹ / ₈ "									
	K	91 ¹ / ₈ "									

Grid patterns and styles

Series A: Eyebrow

Starburst pattern Available in deluxe or flat grids between the glass.

Maximum number of spokes: 5 Minimum width for 5 spokes: 60"



Starburst

Series B to K: Extended arch

Colonial pattern Available in deluxe or flat grids between the glass.

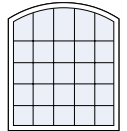

Colonial



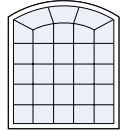











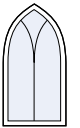
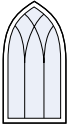
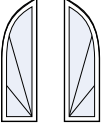
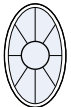
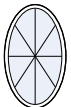
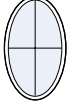
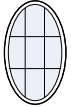

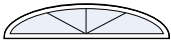









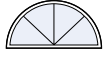

Cathedral pattern Available in deluxe or flat grids between the glass.

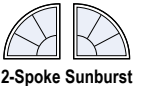
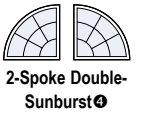

Cathedral

Series	Rough Opening Width									
	24"	28"	32"	36"	40"	44"	48"	60"	72"	96"
A	12"	12 ³ / ₈ "	13 ¹ / ₂ "	14 ¹ / ₄ "	15 ¹ / ₁₆ "	15 ³ / ₄ "	16 ³ / ₈ "	18 ³ / ₈ "	13 ³ / ₈ "	25 ¹ / ₁₆ "
B	24"	24 ³ / ₈ "	25 ¹ / ₂ "	26 ¹ / ₄ "	27 ¹ / ₁₆ "	27 ³ / ₄ "	28 ³ / ₈ "	30 ³ / ₈ "	33 ³ / ₈ "	37 ¹ / ₁₆ "
C	36"	36 ³ / ₈ "	37 ¹ / ₂ "	38 ¹ / ₄ "	39 ¹ / ₁₆ "	39 ³ / ₄ "	40 ³ / ₈ "	42 ³ / ₈ "	45 ³ / ₈ "	
D	44"	44 ³ / ₈ "	45 ¹ / ₂ "	46 ¹ / ₄ "	47 ¹ / ₁₆ "	47 ³ / ₄ "	48 ³ / ₈ "	50 ³ / ₈ "	53 ³ / ₈ "	
E	48"	48 ³ / ₈ "	49 ¹ / ₂ "	50 ¹ / ₄ "	51 ¹ / ₁₆ "	51 ³ / ₄ "	52 ³ / ₈ "	54 ³ / ₈ "	57 ¹ / ₈ "	
F	52"	52 ³ / ₈ "	53 ¹ / ₂ "	54 ¹ / ₄ "	55 ¹ / ₁₆ "	55 ³ / ₄ "	56 ³ / ₈ "	58 ³ / ₈ "	61 ¹ / ₈ "	
G	60"	60 ³ / ₈ "	61 ¹ / ₂ "	62 ¹ / ₄ "	63 ¹ / ₁₆ "	63 ³ / ₄ "	64 ³ / ₈ "	66 ³ / ₈ "		
H	66"	66 ³ / ₈ "	67 ¹ / ₂ "	68 ¹ / ₄ "	69 ¹ / ₁₆ "	69 ³ / ₄ "	70 ³ / ₈ "	72 ³ / ₈ "		
I	72"	72 ³ / ₈ "	73 ¹ / ₂ "	74 ¹ / ₄ "	75 ¹ / ₁₆ "	75 ³ / ₄ "	76 ³ / ₈ "			
J	84"	84 ³ / ₈ "	85 ¹ / ₂ "	86 ¹ / ₄ "	87 ¹ / ₁₆ "	87 ³ / ₄ "	88 ³ / ₈ "			
K	96"	96 ³ / ₈ "	97 ¹ / ₂ "	98 ¹ / ₄ "						

Rough opening height above equals shoulder height plus chord height plus 1/2".

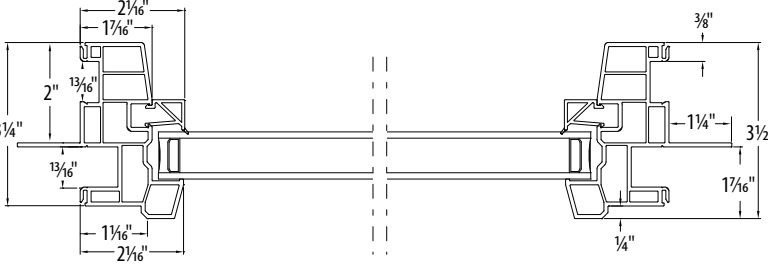
Circle	Gothic/ Half-Gothic	Oval/ Half-Oval	Elliptical	Octagon	Half-Round	Quarter-Round ¹																																																																																																																																												
 <p>Sunburst</p>  <p>Starburst²</p>  <p>Colonial Four-Lite</p>  <p>Colonial Nine-Lite</p> <table border="1"> <tr><th>Size</th><th>Unit</th></tr> <tr><th>Dimensions</th><th>Dimensions</th></tr> <tr><td>CI2424</td><td>23½" x 23½"</td></tr> <tr><td>CI3030</td><td>29½" x 29½"</td></tr> <tr><td>CI3636</td><td>35½" x 35½"</td></tr> </table>	Size	Unit	Dimensions	Dimensions	CI2424	23½" x 23½"	CI3030	29½" x 29½"	CI3636	35½" x 35½"	 <p>One-Stem Tracery²</p>  <p>Two-Stem Tracery²</p> <table border="1"> <tr><th>Size</th><th>Unit</th></tr> <tr><th>Dimensions</th><th>Dimensions</th></tr> <tr><td>GO1836</td><td>17½" x 35½"</td></tr> <tr><td>GO2040</td><td>19½" x 39½"</td></tr> <tr><td>GO2244</td><td>21½" x 43½"</td></tr> <tr><td>GO2448</td><td>23½" x 47½"</td></tr> <tr><td>GO2856</td><td>27½" x 55½"</td></tr> <tr><td>GO3060</td><td>29½" x 59½"</td></tr> <tr><td>GO3672</td><td>35½" x 71½"</td></tr> </table> <p>Half-Gothic</p>  <p>Starburst²</p> <table border="1"> <tr><th>Size</th><th>Unit</th></tr> <tr><th>Dimensions</th><th>Dimensions</th></tr> <tr><td>HGO1854</td><td>17½" x 53½"</td></tr> <tr><td>HGO2260</td><td>21½" x 59½"</td></tr> <tr><td>HGO2666</td><td>25½" x 65½"</td></tr> <tr><td>HGO2872</td><td>27½" x 71½"</td></tr> </table>	Size	Unit	Dimensions	Dimensions	GO1836	17½" x 35½"	GO2040	19½" x 39½"	GO2244	21½" x 43½"	GO2448	23½" x 47½"	GO2856	27½" x 55½"	GO3060	29½" x 59½"	GO3672	35½" x 71½"	Size	Unit	Dimensions	Dimensions	HGO1854	17½" x 53½"	HGO2260	21½" x 59½"	HGO2666	25½" x 65½"	HGO2872	27½" x 71½"	 <p>Sunburst</p>  <p>Starburst²</p>  <p>Colonial Four-Lite</p>  <p>Colonial Nine-Lite</p> <table border="1"> <tr><th>Size</th><th>Unit</th></tr> <tr><th>Dimensions</th><th>Dimensions</th></tr> <tr><td>OV2436</td><td>23½" x 35½"</td></tr> <tr><td>OV3656</td><td>35½" x 55½"</td></tr> </table> <p>Half-Oval</p>  <p>Sunburst</p>  <p>Starburst</p> <table border="1"> <tr><th>Size</th><th>Unit</th></tr> <tr><th>Dimensions</th><th>Dimensions</th></tr> <tr><td>HOV2418</td><td>23½" x 17½"</td></tr> <tr><td>HOV3628</td><td>35½" x 27½"</td></tr> </table>	Size	Unit	Dimensions	Dimensions	OV2436	23½" x 35½"	OV3656	35½" x 55½"	Size	Unit	Dimensions	Dimensions	HOV2418	23½" x 17½"	HOV3628	35½" x 27½"	 <p>Starburst 3-Spoke</p>  <p>Sunstar 5-Spoke³</p>  <p>Sunburst 5-Spoke³</p> <table border="1"> <tr><th>Size</th><th>Unit</th></tr> <tr><th>Dimensions</th><th>Dimensions</th></tr> <tr><td>EL6018</td><td>59½" x 17½"</td></tr> <tr><td>EL7220</td><td>71½" x 19½"</td></tr> <tr><td>EL8420</td><td>83½" x 19½"</td></tr> <tr><td>EL9620</td><td>95½" x 19½"</td></tr> </table> <p>For standard and custom orders, the maximum number of spokes is 5.</p>	Size	Unit	Dimensions	Dimensions	EL6018	59½" x 17½"	EL7220	71½" x 19½"	EL8420	83½" x 19½"	EL9620	95½" x 19½"	 <p>Sunburst</p>  <p>Colonial Four-Lite</p>  <p>Colonial Nine-Lite</p> <table border="1"> <tr><th>Size</th><th>Unit</th></tr> <tr><th>Dimensions</th><th>Dimensions</th></tr> <tr><td>OT2424</td><td>23½" x 23½"</td></tr> <tr><td>OT3232</td><td>31½" x 31½"</td></tr> <tr><td>OT3636</td><td>35½" x 35½"</td></tr> </table>	Size	Unit	Dimensions	Dimensions	OT2424	23½" x 23½"	OT3232	31½" x 31½"	OT3636	35½" x 35½"	 <p>Sunburst⁴</p>  <p>Double-Sunburst⁴</p>  <p>Triple-Sunburst⁴</p>  <p>5-Spoke Sunburst⁴</p>  <p>5-Spoke Double-Sunburst⁴</p>  <p>5-Spoke Triple-Sunburst⁴</p>  <p>Starburst</p>  <p>5-Spoke Starburst⁴</p>  <p>Sunstar⁵</p>  <p>Double-Sunburst⁴</p>  <p>5-Spoke Triple-Sunburst⁴</p> <table border="1"> <tr><th>Size</th><th>Unit</th></tr> <tr><th>Dimensions</th><th>Dimensions</th></tr> <tr><td>HR2412</td><td>23½" x 11½"</td></tr> <tr><td>HR2814</td><td>27½" x 13½"</td></tr> <tr><td>HR3015</td><td>29½" x 14½"</td></tr> <tr><td>HR3216</td><td>31½" x 15½"</td></tr> <tr><td>HR3618</td><td>35½" x 17½"</td></tr> <tr><td>HR4020</td><td>39½" x 19½"</td></tr> <tr><td>HR4422</td><td>43½" x 21½"</td></tr> <tr><td>HR4824</td><td>47½" x 23½"</td></tr> <tr><td>HR5628</td><td>55½" x 27½"</td></tr> <tr><td>HR6030</td><td>59½" x 29½"</td></tr> <tr><td>HR6432</td><td>63½" x 31½"</td></tr> <tr><td>HR7236</td><td>71½" x 35½"</td></tr> <tr><td>HR7437</td><td>73½" x 36½"</td></tr> </table> <p>For standard and custom orders, the maximum number of spokes is 5.</p>	Size	Unit	Dimensions	Dimensions	HR2412	23½" x 11½"	HR2814	27½" x 13½"	HR3015	29½" x 14½"	HR3216	31½" x 15½"	HR3618	35½" x 17½"	HR4020	39½" x 19½"	HR4422	43½" x 21½"	HR4824	47½" x 23½"	HR5628	55½" x 27½"	HR6030	59½" x 29½"	HR6432	63½" x 31½"	HR7236	71½" x 35½"	HR7437	73½" x 36½"	 <p>2-Spoke Sunburst</p>  <p>2-Spoke Double-Sunburst⁴</p>  <p>2-Spoke Starburst</p>  <p>1-Spoke Sunstar</p>  <p>2-Spoke Sunstar</p>  <p>1-Spoke Double-Sunstar⁴</p>  <p>2-Spoke Double-Sunstar⁴</p> <table border="1"> <tr><th>Size (LEFT)</th><th>Unit</th></tr> <tr><th>Dimensions</th><th>Dimensions</th></tr> <tr><td>QRL2020</td><td>19½" x 19½"</td></tr> <tr><td>QRL2424</td><td>23½" x 23½"</td></tr> <tr><td>QRL2828</td><td>27½" x 27½"</td></tr> <tr><td>QRL3030</td><td>29½" x 29½"</td></tr> <tr><td>QRL3232</td><td>31½" x 31½"</td></tr> <tr><td>QRL3636</td><td>35½" x 35½"</td></tr> </table> <p>(left as viewed from outside)</p> <table border="1"> <tr><th>Size (RIGHT)</th><th>Unit</th></tr> <tr><th>Dimensions</th><th>Dimensions</th></tr> <tr><td>QRR2020</td><td>19½" x 19½"</td></tr> <tr><td>QRR2424</td><td>23½" x 23½"</td></tr> <tr><td>QRR2828</td><td>27½" x 27½"</td></tr> <tr><td>QRR3030</td><td>29½" x 29½"</td></tr> <tr><td>QRR3232</td><td>31½" x 31½"</td></tr> <tr><td>QRR3636</td><td>35½" x 35½"</td></tr> </table> <p>(right as viewed from outside)</p>	Size (LEFT)	Unit	Dimensions	Dimensions	QRL2020	19½" x 19½"	QRL2424	23½" x 23½"	QRL2828	27½" x 27½"	QRL3030	29½" x 29½"	QRL3232	31½" x 31½"	QRL3636	35½" x 35½"	Size (RIGHT)	Unit	Dimensions	Dimensions	QRR2020	19½" x 19½"	QRR2424	23½" x 23½"	QRR2828	27½" x 27½"	QRR3030	29½" x 29½"	QRR3232	31½" x 31½"	QRR3636	35½" x 35½"
Size	Unit																																																																																																																																																	
Dimensions	Dimensions																																																																																																																																																	
CI2424	23½" x 23½"																																																																																																																																																	
CI3030	29½" x 29½"																																																																																																																																																	
CI3636	35½" x 35½"																																																																																																																																																	
Size	Unit																																																																																																																																																	
Dimensions	Dimensions																																																																																																																																																	
GO1836	17½" x 35½"																																																																																																																																																	
GO2040	19½" x 39½"																																																																																																																																																	
GO2244	21½" x 43½"																																																																																																																																																	
GO2448	23½" x 47½"																																																																																																																																																	
GO2856	27½" x 55½"																																																																																																																																																	
GO3060	29½" x 59½"																																																																																																																																																	
GO3672	35½" x 71½"																																																																																																																																																	
Size	Unit																																																																																																																																																	
Dimensions	Dimensions																																																																																																																																																	
HGO1854	17½" x 53½"																																																																																																																																																	
HGO2260	21½" x 59½"																																																																																																																																																	
HGO2666	25½" x 65½"																																																																																																																																																	
HGO2872	27½" x 71½"																																																																																																																																																	
Size	Unit																																																																																																																																																	
Dimensions	Dimensions																																																																																																																																																	
OV2436	23½" x 35½"																																																																																																																																																	
OV3656	35½" x 55½"																																																																																																																																																	
Size	Unit																																																																																																																																																	
Dimensions	Dimensions																																																																																																																																																	
HOV2418	23½" x 17½"																																																																																																																																																	
HOV3628	35½" x 27½"																																																																																																																																																	
Size	Unit																																																																																																																																																	
Dimensions	Dimensions																																																																																																																																																	
EL6018	59½" x 17½"																																																																																																																																																	
EL7220	71½" x 19½"																																																																																																																																																	
EL8420	83½" x 19½"																																																																																																																																																	
EL9620	95½" x 19½"																																																																																																																																																	
Size	Unit																																																																																																																																																	
Dimensions	Dimensions																																																																																																																																																	
OT2424	23½" x 23½"																																																																																																																																																	
OT3232	31½" x 31½"																																																																																																																																																	
OT3636	35½" x 35½"																																																																																																																																																	
Size	Unit																																																																																																																																																	
Dimensions	Dimensions																																																																																																																																																	
HR2412	23½" x 11½"																																																																																																																																																	
HR2814	27½" x 13½"																																																																																																																																																	
HR3015	29½" x 14½"																																																																																																																																																	
HR3216	31½" x 15½"																																																																																																																																																	
HR3618	35½" x 17½"																																																																																																																																																	
HR4020	39½" x 19½"																																																																																																																																																	
HR4422	43½" x 21½"																																																																																																																																																	
HR4824	47½" x 23½"																																																																																																																																																	
HR5628	55½" x 27½"																																																																																																																																																	
HR6030	59½" x 29½"																																																																																																																																																	
HR6432	63½" x 31½"																																																																																																																																																	
HR7236	71½" x 35½"																																																																																																																																																	
HR7437	73½" x 36½"																																																																																																																																																	
Size (LEFT)	Unit																																																																																																																																																	
Dimensions	Dimensions																																																																																																																																																	
QRL2020	19½" x 19½"																																																																																																																																																	
QRL2424	23½" x 23½"																																																																																																																																																	
QRL2828	27½" x 27½"																																																																																																																																																	
QRL3030	29½" x 29½"																																																																																																																																																	
QRL3232	31½" x 31½"																																																																																																																																																	
QRL3636	35½" x 35½"																																																																																																																																																	
Size (RIGHT)	Unit																																																																																																																																																	
Dimensions	Dimensions																																																																																																																																																	
QRR2020	19½" x 19½"																																																																																																																																																	
QRR2424	23½" x 23½"																																																																																																																																																	
QRR2828	27½" x 27½"																																																																																																																																																	
QRR3030	29½" x 29½"																																																																																																																																																	
QRR3232	31½" x 31½"																																																																																																																																																	
QRR3636	35½" x 35½"																																																																																																																																																	
<p>Custom Shapes</p> <p>Traditional rectangular, trapezoid, parallelogram, and other shapes utilizing fixed frames are available</p>		 <p>Geometric Windows, Extended Arch and Eyebrow Horizontal Detail</p>																																																																																																																																																

Fixed extended arch and eyebrow windows have an interior frame depth of 2" and an exterior projection from the nail fin of 1-3/4".

Callout sizes are expressed in inches (width) and equal rough opening.

















































































Geometric windows have an interior frame depth of 2"; exterior projection of the frame is 1-3/16" from the nail fin.



























Callout sizes are expressed in inches (width x height) and equal rough opening.

Unless otherwise noted, patterns are available in deluxe or flat grids between the glass.

Note: When geometric and picture windows are muller together, sightlines will not be even.

- 1 Specify left-hand or right-hand as viewed from the exterior.
 - 2 Available with flat grids between the glass only.
 - 3 Starburst, Sunburst, and Sunstar (5-spoke) patterns: minimum window size is 60" for either deluxe or flat grids.
 - 4 Double-Sunburst and Double-Sunstar patterns: minimum window size is 48" for either deluxe or flat grids.
 - 5 Sunstar and Sunburst (3-spoke) patterns: minimum window size is 28" for deluxe grids.
 - 6 Triple-Sunstar and Triple-Sunburst patterns: minimum window size is 72" for either deluxe or flat grids.
 - 7 All sizes shown meet DP50 rating.
- For the latest testing data, contact Customer Service or visit our website at www.Viwinco.com

Rough Opening	Picture										
	12"	20"	24"	28"	32"	36"	40"	44"	48"	60"	
Unit Size	11½"	19½"	23½"	27½"	31½"	35½"	39½"	43½"	47½"	59½"	
Visible Glass	5¾"	13¾"	17¾"	21¾"	25¾"	29¾"	33¾"	37¾"	41¾"	53¾"	
36"	35½"										
	29¾"	PX1236	PX2036	PX2436	PX2836	PX3236	PX3636	PX4036	PX4436	PX4836	PX6036
42"	41½"										
	35¾"	PX1242	PX2042	PX2442	PX2842	PX3242	PX3642	PX4042	PX4442	PX4842	PX6042
44"	43½"										
	37¾"	PX1244	PX2044	PX2444	PX2844	PX3244	PX3644	PX4044	PX4444	PX4844	PX6044
48"	47½"										
	41¾"	PX1248	PX2048	PX2448	PX2848	PX3248	PX3648	PX4048	PX4448	PX4848	PX6048
52"	51½"										
	45¾"	PX1252	PX2052	PX2452	PX2852	PX3252	PX3652	PX4052	PX4452	PX4852	PX6052
60"	59½"										
	53¾"	PX1260	PX2060	PX2460	PX2860	PX3260	PX3660	PX4060	PX4460	PX4860	PX6060
66"	65½"										
	59¾"	PX1266	PX2066	PX2466	PX2866	PX3266	PX3666	PX4066	PX4466	PX4866	PX6066
72"	71½"										
	65¾"	PX1272	PX2072	PX2472	PX2872	PX3272	PX3672	PX4072	PX4472	PX4872	PX6072

Rough Opening	Transom												
	28"	30"	32"	36"	40"	44"	48"	52"	56"	64"	72"		
Unit Size	27½"	29½"	31½"	35½"	39½"	43½"	47½"	51½"	55½"	63½"	71½"		
Visible Glass	21¾"	23¾"	25¾"	29¾"	33¾"	37¾"	41¾"	45¾"	49¾"	57¾"	65¾"		
12"	11½"	5¾"											
			TSM2812	TSM3012	TSM3212	TSM3612	TSM4012	TSM4412	TSM4812	TSM5212	TSM5612	TSM6412	TSM7212
			18"	17½"	11¾"								
TSM2818	TSM3018	TSM3218				TSM3618	TSM4018	TSM4418	TSM4818	TSM5218	TSM5618	TSM6418	TSM7218
24"	23½"	17¾"											
			TSM2824	TSM3024	TSM3224	TSM3624	TSM4024	TSM4424	TSM4824	TSM5224	TSM5624	TSM6424	TSM7224

Picture & Transom
Vertical Detail

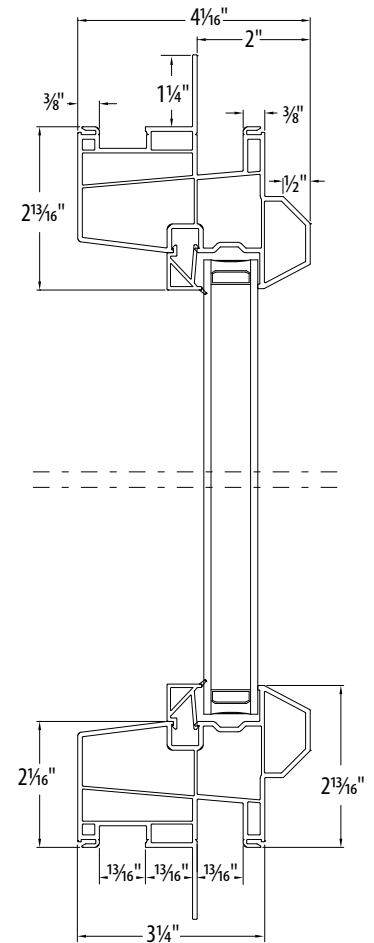













































Callout sizes are expressed in inches (width x height) and equal rough opening.

Picture and transom windows have an interior frame depth of 2"; exterior projection of the frame is 1-3/16" from the nail fin.

When mulling a unit to a picture or transom overall rough opening is not affected by the mullion.

 Meets DP50 rating. Specify DP50 when ordering.

For the latest testing data, contact Customer Service or visit our website at www.viwinco.com

Rough Opening	Casement					
	18"	20"	24"	28"	30"	36"
Unit Size	17½"	19½"	23½"	27½"	29½"	35½"
Sash Opening	4⅞"	6⅞"	10⅞"	14⅞"	16⅞"	22⅞"
Visible Glass-Sash	11¼"	13¼"	17¼"	21¼"	23¼"	29¼"
24"	 CX1824	 CX2024	 CX2424	—	—	—
36"	 CX1836	 CX2036	 CX2436	 CX2836	 CX3036	 CX3636
42"	 CX1842	 CX2042	 CX2442	 CX2842	 CX3042	 CX3642 ②
48"	 CX1848	 CX2048	 CX2448	 CX2848	 CX3048 ②	 CX3648 ①
52"	 CX1852	 CX2052	 CX2452	 CX2852	 CX3052 ②	 CX3652 ①
60"	 CX1860	 CX2060	 CX2460	 CX2860	 CX3060 ②	 CX3660 ①
66"	 CX1866	 CX2066	 CX2466	 CX2866	 CX3066 ②	 CX3666 ①
72"	 CX1872	 CX2072	 CX2472	 CX2872	 CX3072 ②	 CX3672 ①

Casement Cross-Sectional Head & Sill Detail

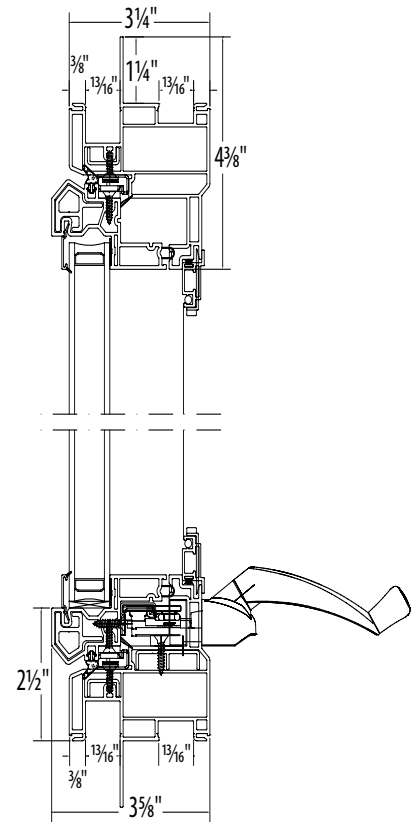

Rough Opening	Twin Casement				
	36"	40"	48"	56"	72"
Unit Size	35½"	39½"	47½"	55½"	71½"
Sash Opening	47⁄8"	67⁄8"	107⁄8"	147⁄8"	227⁄8"
Visible Glass-Sash	11¼"	13¼"	17¼"	21¼"	29¼"
24"	23½"	17¼"	17¼"	—	—
36"	35½"	29¼"	29¼"	—	—
42"	41½"	35¼"	35¼"	—	—
48"	47½"	41¼"	41¼"	—	—
52"	51½"	45¼"	45¼"	—	—
60"	59½"	53¼"	53¼"	—	—
66"	65½"	58¼"	58¼"	—	—
72"	71½"	65¼"	65¼"	—	—

Twin Casement Cross-Sectional Jamb Detail with Integral Mullion

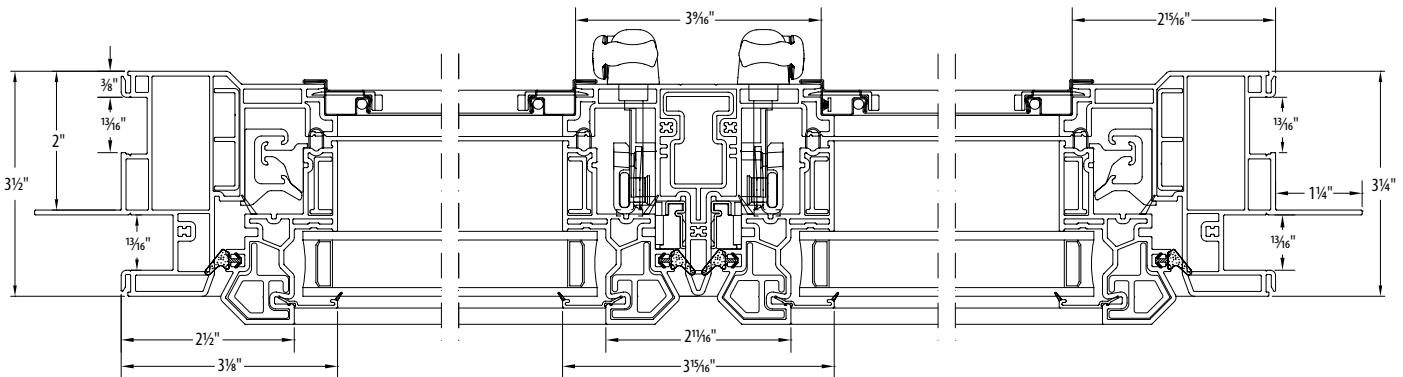

Callout sizes are expressed in inches and equal rough opening. Casement and awning windows have an interior frame depth of 2" and an exterior projection of 1-5/8" from the nail fin.

When mulling a unit to a casement, overall rough opening is not affected by the mullion.

- Meets egress of:
Clear opening area ≥ 5.7 sq. ft.
Clear opening width ≥ 20"
Clear opening height ≥ 24"
- All windows that can meet egress with egress hardware will automatically be manufactured to meet egress.

■ Meets DP50 rating. Specify DP50 when ordering.

For the latest testing data, contact Customer Service.

Colonial casement grid pattern option available for single casements and twin casement sizes.

Colonial casements are designed to mimic the look of double-hung and single-hung windows but offer the larger opening of a casement. To order: Single casement - use the callout prefix CCX. Twin casement - use the callout prefix TCCX.

Consult Customer Service for the exact grid pattern. Final grid layout to be approved by customer.

For the latest testing data, contact Customer Service or visit our website at www.viwinco.com

Rough Opening	Quad Casement			
	72"	80"	96"	112"
Unit Size	71½"	79½"	95½"	111½"
Sash Opening	47⁄8"	67⁄8"	107⁄8"	147⁄8"
Visible Glass-Sash	11¼"	13¼"	17¼"	21¼"
24"	23½"	17¼"	17¼"	
36"	35½"	29¼"	29¼"	
42"	41½"	35¼"	35¼"	
48"	47½"	41¼"	41¼"	
52"	51½"	45¼"	45¼"	
60"	59½"	53¼"	53¼"	
66"	65½"	58¼"	58¼"	
72"	71½"	65¼"	65¼"	

WW4U7236	WW4U8036	WW4U9636	WW4U11236
WW4U7242	WW4U8042	WW4U9642	WW4U11242
WW4U7248	WW4U8048	WW4U9648	WW4U11248
WW4U7252	WW4U8052	WW4U9652	WW4U11252
WW4U7260	WW4U8060	WW4U9660	WW4U11260
WW4U7266	WW4U8066	WW4U9666	WW4U11266
WW4U7272	WW4U8072	WW4U9672	WW4U11272

Quad Casement Cross-Sectional Jamb Detail with Integral Mullions

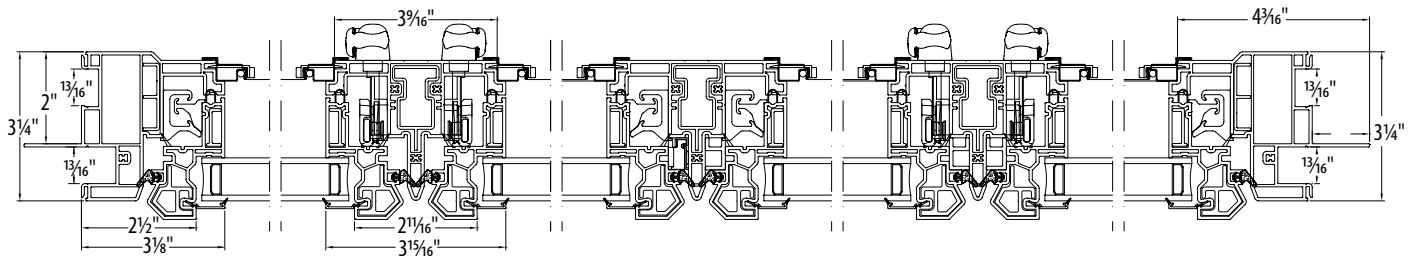

Rough Opening	Casement/Picture/Casement				
	54"	60"	72"	84"	108"
Unit Size	53½"	59½"	71½"	83½"	107½"
Sash Opening	47⁸⁄₈"	67⁸⁄₈"	107⁸⁄₈"	147⁸⁄₈"	227⁸⁄₈"
Visible Glass-Sash	11¼"	13¼"	17¼"	21¼"	29¼"
24"	23½"	—	—	—	—
	17¼"	—	—	—	—
36"	35½"	—	—	—	—
	29¼"	—	—	—	—
42"	41½"	—	—	—	—
	35¼"	—	—	—	—
48"	47½"	—	—	—	—
	41¼"	—	—	—	—
52"	51½"	—	—	—	—
	45¼"	—	—	—	—
60"	59½"	—	—	—	—
	53¼"	—	—	—	—
66"	65½"	—	—	—	—
	58¼"	—	—	—	—
72"	71½"	—	—	—	—
	65¼"	—	—	—	—

Casement/Picture/Casement Cross-Sectional Jamb Detail with Integral Mullions

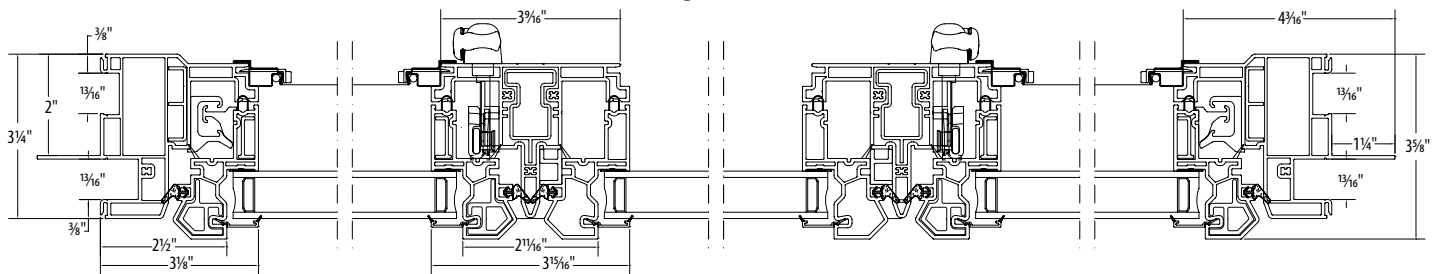

Callout sizes are expressed in inches and equal rough opening. Casement and awning windows have an interior frame depth of 2" and an exterior projection of 1-5/8" from the nail fin.

When mulling a unit to a casement, overall rough opening is not affected by the mullion.

- Meets egress of:
Clear opening area ≥ 5.7 sq. ft.
Clear opening width ≥ 20"
Clear opening height ≥ 24"
- All windows that can meet egress with egress hardware will automatically be manufactured to meet egress.

■ Meets DP50 rating. Specify DP50 when ordering.





















































For the latest testing data, contact Customer Service.

Colonial casement grid pattern option available for single casements and twin casement sizes.

Colonial casements are designed to mimic the look of double-hung and single-hung windows but offer the larger opening of a casement. To order: Single casement - use the callout prefix CCX. Twin casement - use the callout prefix TCCX.

Consult Customer Service for the exact grid pattern. Final grid layout to be approved by customer.

For the latest testing data, contact Customer Service or visit our website at www.viwinco.com

Rough Opening			Casement Picture Fixed							
			20"	24"	28"	30"	36"	42"	48"	60"
Unit Size			19½"	23½"	27½"	29½"	35½"	41½"	47½"	59½"
Visible Glass			13¼"	17¼"	21¼"	23¼"	29¼"	35¼"	41¼"	53¼"
36"	35½"	29¼"	 CPX2036	 CPX2436	 CPX2836	 CPX3036	 CPX3636	 CPX4236	 CPX4836	 CPX6036
	42"	41½"	35¼"	 CPX2042	 CPX2442	 CPX2842	 CPX3042	 CPX3642	 CPX4242	 CPX4842
48"	47½"	41¼"	 CPX2048	 CPX2448	 CPX2848	 CPX3048	 CPX3648	 CPX4248	 CPX4848	 CPX6048
	52"	51½"	45¼"	 CPX2052	 CPX2452	 CPX2852	 CPX3052	 CPX3652	 CPX4252	 CPX4852
60"	59½"	53¼"	 CPX2060	 CPX2460	 CPX2860	 CPX3060	 CPX3660	 CPX4260	 CPX4860	 CPX6060
	66"	65½"	59¼"	 CPX2066	 CPX2466	 CPX2866	 CPX3066	 CPX3666	 CPX4266	 CPX4866
72"	71½"	65¼"	 CPX2072	 CPX2472	 CPX2872	 CPX3072	 CPX3672	 CPX4272	 CPX4872	 CPX6072

Casement Picture (Fixed)
Cross-Sectional Head
and Sill Detail

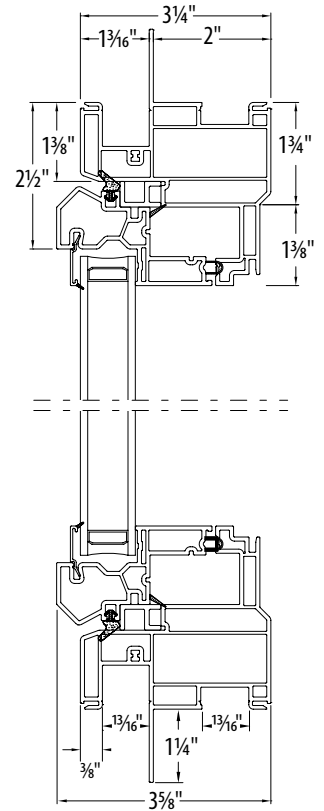





























Callout sizes are expressed in inches (width x height) and equal rough opening.

Casement picture windows have an interior frame depth of 2"; exterior projection of the frame is 1-3/16" from the nail fin.

When mulling a unit to a casement picture overall rough opening is not affected by the mullion.

Meets DP50 rating. Specify DP50 when ordering.

For the latest testing data, contact Customer Service or visit our website at www.viwinco.com

Rough Opening			Awning					
			24"	36"	40"	48"	56"	60"
Unit Size			23½"	35½"	39½"	47½"	55½"	59½"
Visible Glass			17¼"	29¼"	33¼"	41¼"	49¼"	53¼"
18"	17½"	11¼"	 AX2418	 AX3618	 AX4018	 AX4818	 AX5618	 AX6018
	20"	19½"	13¼"	 AX2420	 AX3620	 AX4020	 AX4820	 AX5620
24"	23½"	17¼"	 AX2424	 AX3624	 AX4024	 AX4824	 AX5624	 AX6024
28"	27½"	21¼"	 AX2428	 AX3628	 AX4028	 AX4828	 AX5628	 AX6028
36"	35½"	29¼"	 AX2436	 AX3636	 AX4036	 AX4836	 AX5636	 AX6036

Awning Cross-Sectional Jamb Detail

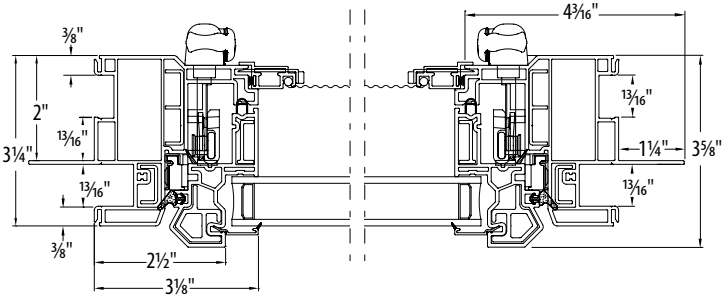







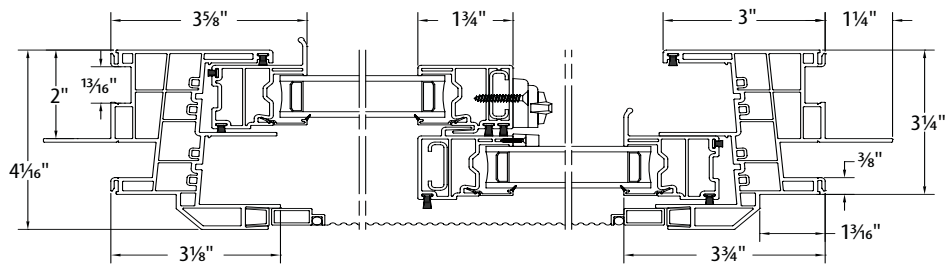





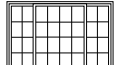

Callout sizes are expressed in inches and equal rough opening.
 Casement and awning windows have an interior frame depth of 2" and an exterior projection of 1-5/8" from the nail fin.
 When mulling a unit to a casement or awning, overall rough opening is not affected by the mullion.
 Meets DP50 rating. Specify DP50 when ordering.
 For the latest testing data, contact Customer Service or visit our website at www.Viwinco.com

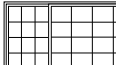
Rough Opening	Double Sliders							
	24"	36"	48"	54"	60"	72"	84"	96"
Unit Size	23½"	35½"	47½"	53½"	59½"	71½"	83½"	95½"
Sash Opening	5⅜"	11⅜"	17⅜"	20⅜"	23⅜"	29⅜"	35⅜"	41⅜"
Visible Glass-Sash	7⅞"	13⅞"	19⅞"	22⅞"	25⅞"	31⅞"	37⅞"	43⅞"
24"	23½"	35½"	47½"	53½"	59½"	71½"	83½"	95½"
	2SL2424	2SL3624	2SL4824	2SL5424	2SL6024	2SL7224	2SL8424	2SL9624
36"	35½"	35½"	47½"	53½"	59½"	71½"	83½"	95½"
	2SL2436	2SL3636	2SL4836	2SL5436	2SL6036	2SL7236	2SL8436	2SL9636
42"	41½"	35⅝"	47½"	53½"	59½"	71½"	83½"	95½"
	2SL2442	2SL3642	2SL4842	2SL5442	2SL6042	2SL7242	2SL8442	2SL9642
48"	47½"	41⅝"	47½"	53½"	59½"	71½"	83½"	95½"
	2SL2448	2SL3648	2SL4848	2SL5448	2SL6048	2SL7248	2SL8448	2SL9648
60"	59½"	53⅝"	47½"	53½"	59½"	71½"	83½"	95½"
	2SL2460	2SL3660	2SL4860	2SL5460	2SL6060	2SL7260	2SL8460	2SL9660

Double Slider Horizontal Detail



Rough Opening		3-Lite End-Vent Slider (XOX) [®]				
		72"	84"	96"	108"	120"
Unit Size		71½"	83½"	95½"	107½"	119½"
Sash Opening		15⅜"	18⅜"	21⅜"	24⅜"	27⅜"
Total Visible Glass		60⅞"	72⅞"	84⅞"	96⅞"	108⅞"
36"	35½"					
	29⅜"					
	26½"					
48"	47½"					
	41⅜"					
	38½"					
60"	59½"					
	53⅜"					
	50½"					

3-Lite End-Vent Slider (XOX)[®] Horizontal Detail

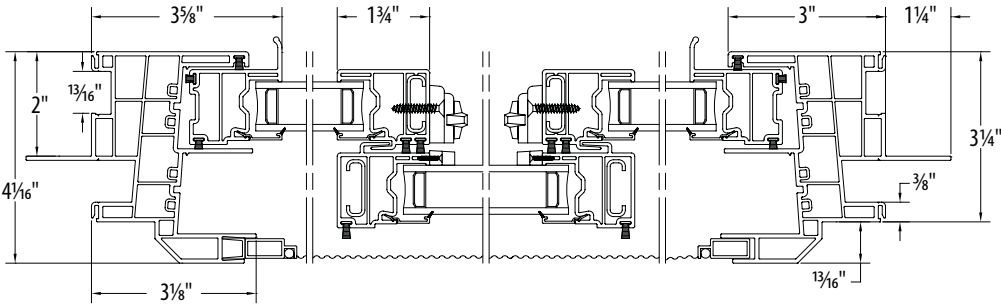

Callout sizes are expressed in inches (width x height) and equal rough opening.

Slider windows have an interior frame depth of 2"; exterior projection of the frame is 1-3/16" from the nail fin.

When mulling a unit to a slider overall rough opening is not affected by the mullion.

Half-screen is standard for 2-lite sliders and a screen for each operable flanker is standard for 3-lite end-vent sliders.

- Meets egress of:
 - Clear opening area ≥ 5.7 sq. ft.
 - Clear opening width ≥ 20"
 - Clear opening height ≥ 24"

- 3-lite end-vent sliders:
 - Fixed center window is 50% of the total unit with operable sashes 25% each
 - Equal-sash 3-lite end-vent slider is also available (XOX option only). Each sash is 33.3% of the total window unit
 - All grid choices are available in the fixed center window
 - Meets DP50 rating. Specify DP50 when ordering.
- For the latest testing data, contact Customer Service or visit our website at www.Viwinco.com

Rough Opening	Double-Hung Bay Windows 10°, 30° and 45°						
	47-1/2" - 60"	61" - 72"	73" - 84"	85" - 96"	97" - 108"	109" - 120"	121" - 144"
32" - 40"							
41" - 50"							
51" - 60"							
61" - 70"							
71" - 80"							

Rough Opening	Casement Bay Windows 10°, 30° and 45°						
	47-1/2" - 60"	61" - 72"	73" - 84"	85" - 96"	97" - 108"	109" - 120"	121" - 144"
32" - 40"							
41" - 50"							
51" - 60"							
61" - 70"							
71" - 80"							

For Casement Bay Windows, each individual Casement unit cannot exceed 36"x72". Each individual Casement Picture unit cannot exceed 72"x72".

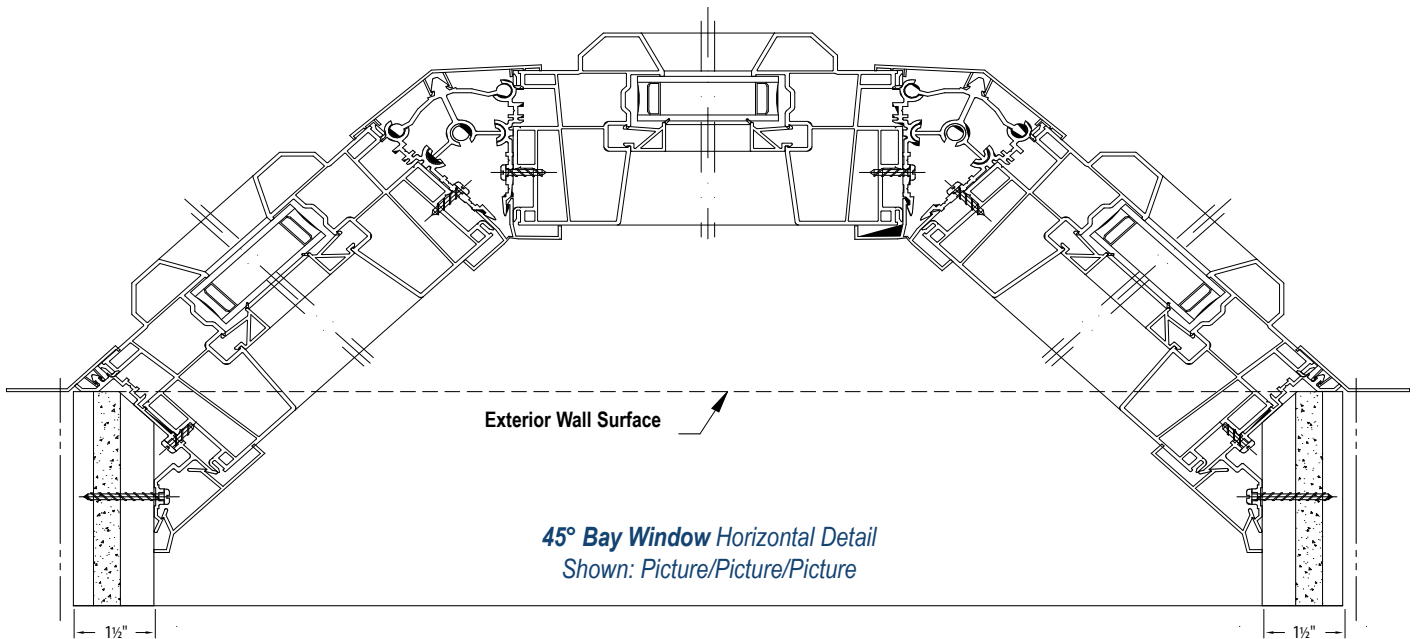

Rough Opening	Double-Hung 3-Lite Bow Windows		Double-Hung 4-Lite Bow Windows		
	47-1/2" - 72"	73" - 91-1/2"	73-1/4" - 95"	96" - 120"	121" - 144"
32" - 40"					
41" - 50"					
51" - 60"					
61" - 70"					
71" - 80"					

10° Bow Window Vertical Detail

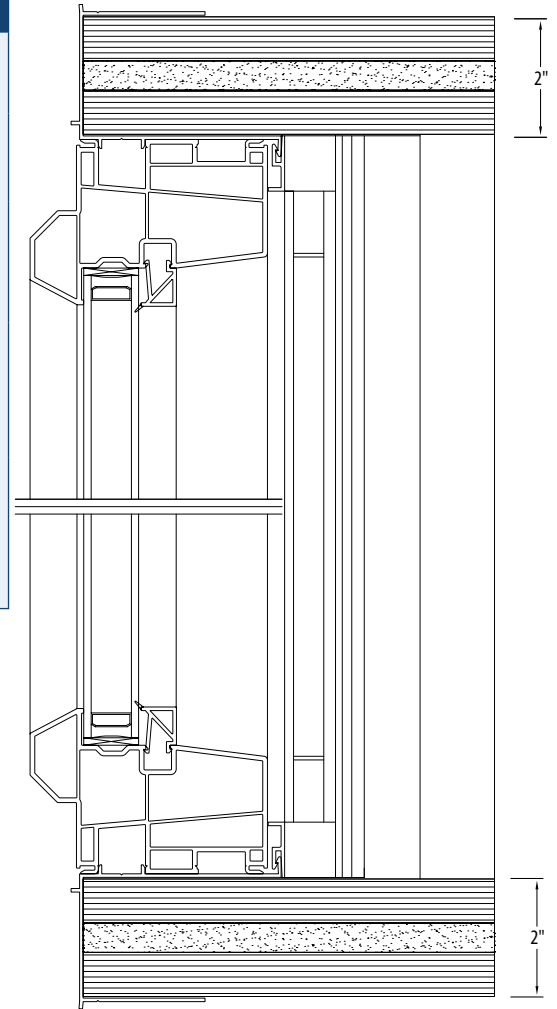









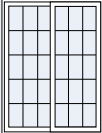
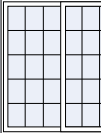

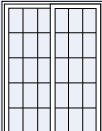
Rough Opening	Double-Hung 5-Lite Bow Windows		
	90-1/2" - 105"	106" - 120"	121" - 144"
32" - 40"			
41" - 50"			
51" - 60"			
61" - 70"			
71" - 80"			

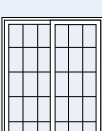
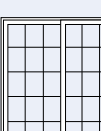
Bays & Bows

- ▶ Design your own bay or bow unit with single-hung, double-hung, casement or picture styles. See individual size charts for dimensions, or order a custom size. Custom jamb depths and projections are available.
- ▶ 2" head and seat board are constructed of 1/2" foam insulation sandwiched between two 3/4" pieces of marine-grade plywood with birch veneer and a 10 mm vinyl exterior. Paintable or stainable (oak veneer headboard and seat board also available as an upgrade).

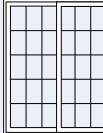
Meets DP50 rating. Specify DP50 when ordering.
 For the latest testing data, contact Customer Service or visit our website at www.Viwinco.com

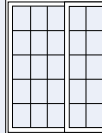
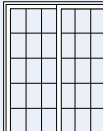
Rough Opening		Patio Door - 2-Panel (XO/OX) KD Assembly® Available		
		60"	72"	96"
Unit Size		59½"	71½"	95½"
80"	79½"	 PD26080	 PD27280 ●	 PD29680
	81½"	 PD26082	 PD27282 ●	 PD29682
96"	95½"	 PD26096	 PD27296	 PD29696

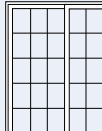
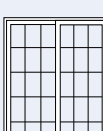
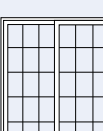
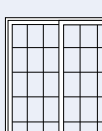
Rough Opening		Patio Door - 3-Panel (OXO) KD Assembly® Available		
		90"	108"	144"
Unit Size		89½"	107½"	143½"
80"	79½"	 PD39080	 PD310880 ●	 PD314480
	81½"	 PD39082	 PD310882 ●	 PD314482
96"	95½"	 PD39096	 PD310896	 PD314496 ●

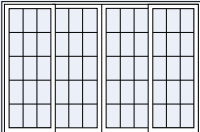
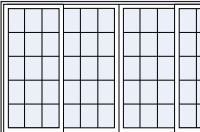
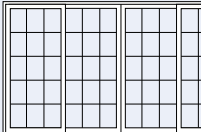
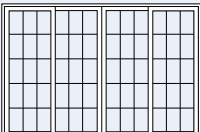
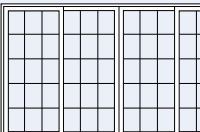
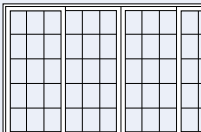
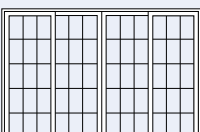
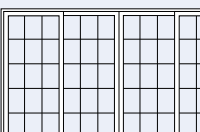
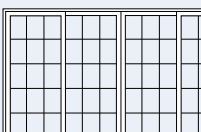
Rough Opening		Patio Door - 4-Panel (OXXO) KD Assembly® Available		
		118"	144"	192"
Unit Size		117½"	143½"	191½"
80"	79½"	 PD411880	 PD414480 ●	 PD419280 ●
	81½"	 PD411882	 PD414482 ●	 PD419282 ●
96"	95½"	 PD411896	 PD414496 ●	 PD419296 ●

Patio Door Cross-Sectional Head and Sill Detail

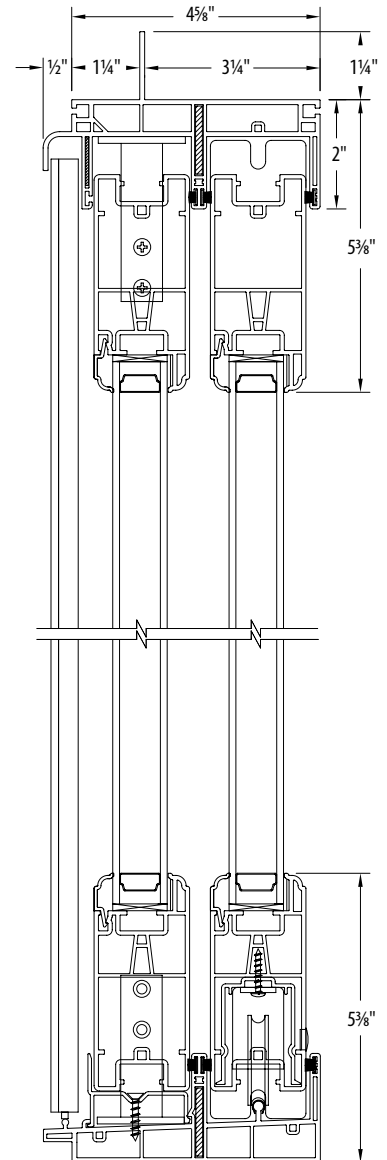

Patio Door Cross-Sectional Jamb Detail

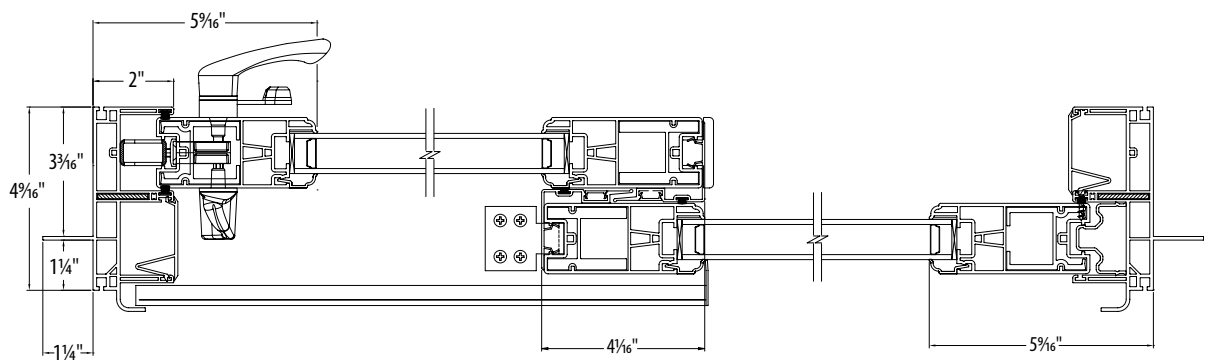

Callout sizes are expressed in inches and equal rough opening.

Patio doors have an interior frame depth of 3-3/8" and an exterior projection of 1-1/2" from the nail fin.

Patio doors are not field reversible.

Two-point lock with adjustable strikes on all patio doors.









● Available with blinds between the glass





● Stock and custom sized doors within shaded zones are KD assembly only

● Knock down assembly

■ Meets DP50 rating. Specify DP50 when ordering.

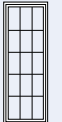
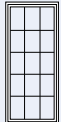
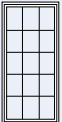
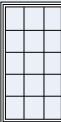
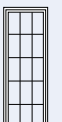
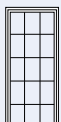

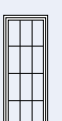
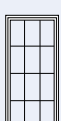
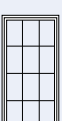
For the latest testing data, contact Customer Service or visit our website at www.Viwinco.com

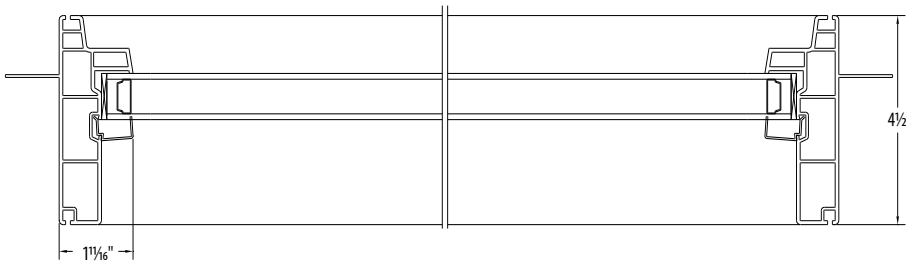

Rough Opening		Patio Door Transom		
		60"	72"	96"
Unit Size		59½"	71½"	97½"
16"	15½"	 PDTSM6016	 PDTSM7216	 PDTSM9616 ②
20"	19½"	 PDTSM6020	 PDTSM7220	 PDTSM9620 ②
24"	23½"	 PDTSM6024 ②	 PDTSM7224 ②	 PDTSM9624 ②

Rough Opening		Patio Door Sidelite			
		32"	38"	42"	48"
Unit Size		31½"	37½"	41½"	47½"
80"	79½"	 PDTSM3280 ②	 PDTSM3880 ②	 PDTSM4280 ②	 PDTSM4880 ②
	82"	 PDTSM3282 ②	 PDTSM3882 ②	 PDTSM4282 ②	 PDTSM4882 ②
96"	95½"	 PDTSM3296 ②	 PDTSM3896 ②	 PDTSM4296 ②	 PDTSM4896 ②

Patio Door Transom Cross-Sectional Jamb Detail



Rough Opening		Geometric shapes for patio doors—half-round		
		60"	72"	96"
Unit Size		59½"	71½"	95½"
30"	29½"	 PDHR6030 ②		
36"	35½"		 PDHR7236 ②	
48"	47½"			 PDHR9648 ②

Rough Opening		Geometric shapes for patio doors—elliptical		
		60"	72"	96"
Unit Size		59½"	71½"	95½"
18"	17½"	 PDEL6018		
20"	19½"		 PDEL7220	 PDEL9620 ②

Grid patterns for geometric shapes—half-round

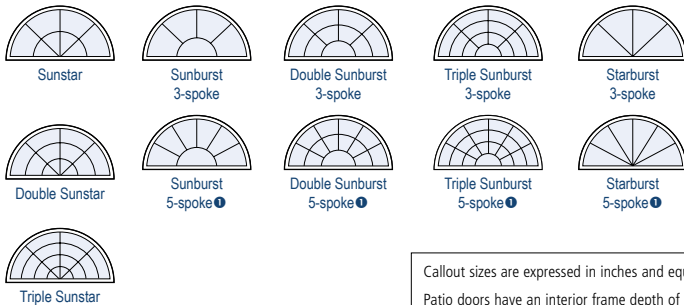

Grid patterns for geometric shapes—elliptical

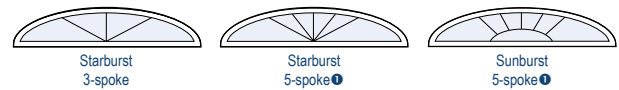

Callout sizes are expressed in inches and equal rough opening. Patio doors have an interior frame depth of 3-3/8" and an exterior projection of 1-1/2" from the nail fin.

Transoms and sidelites have an interior frame depth of 3-3/8" and an exterior projection of 1-3/8" from the nail fin.

When mulling a transom or sidelite to a patio door, add 1" to the overall rough opening total unit dimension for each mullion.

Patio doors are not field reversible.

Two-point lock with adjustable strikes on all patio doors.

① 5-spoke starburst pattern: Minimum window size is 60" for either deluxe or flat grids.

② If a sidelite is mullied to a patio door, the unit will not meet DP50.

③ Meets DP50 rating. Specify DP50 when ordering.

For the latest testing data, contact Customer Service or visit our website at www.viwinco.com

3.5" Flat Casing Picture Frame w/ Pocket Filler
Vertical Detail

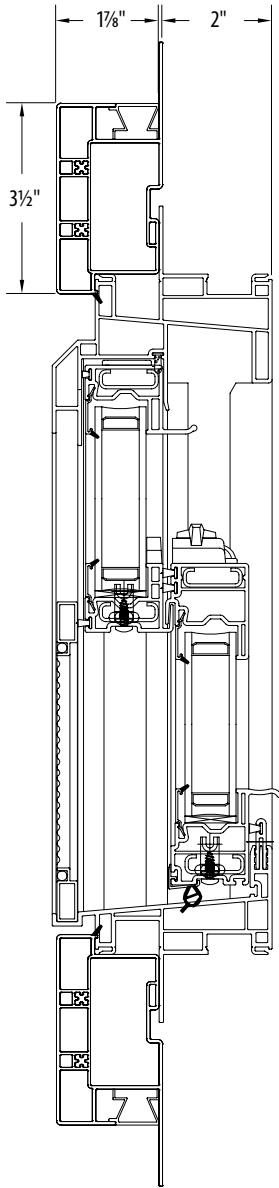

Brick Mold Casing w/ Bullnose Sill and Pocket Filler
Vertical Detail

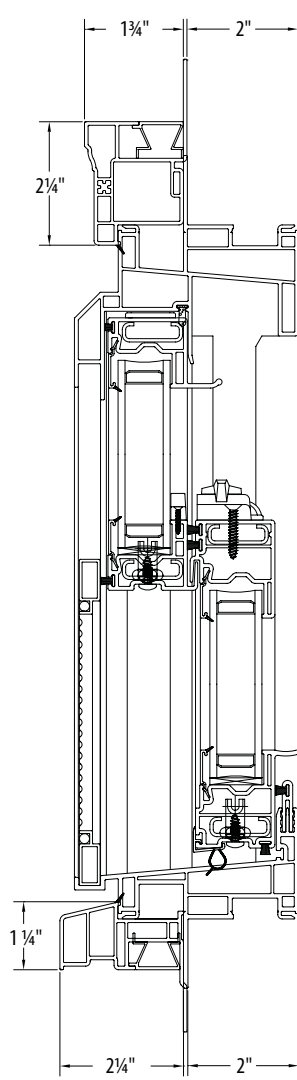

3.5" Flat Casing w/o Pocket Filler Horizontal Detail

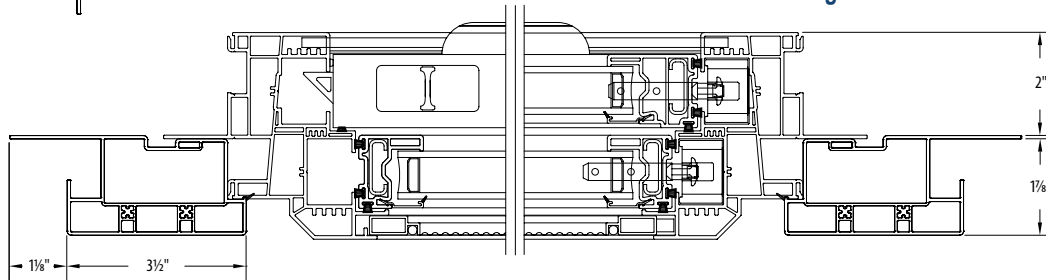

Brick Mold Casing w/o Pocket Filler Horizontal Detail

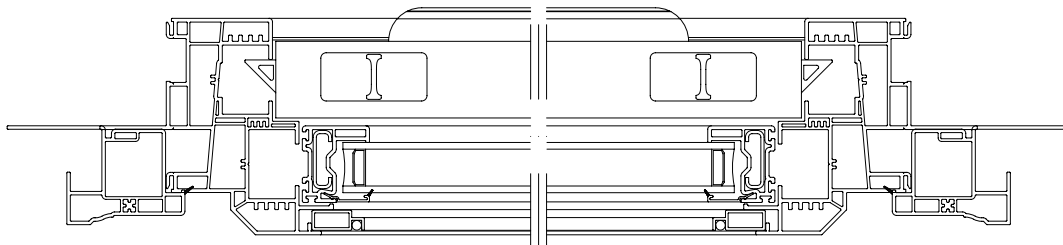



Bold



Custom-Made



Modern



Efficient



Tough





Stylish



Practical



Secure



In order to provide the most accurate data possible, and due to the ever changing codes and continual testing, we have decided to remove our testing data from this brochure.

Our most updated testing and performance data can be located at <http://www.viwinco.com/literature-gallery> for viewing and downloading.

Please contact your local distributor or sales representative for further assistance.

For almost forty years, the people at Viwinco have perfected their skills at producing high-performance, beautiful windows and patio doors. Our products are manufactured in-house from premium-quality materials. We oversee every step of the process—even hand-washing each window or door before it leaves our facility. Drawing on a work ethic passed down through generations, our family-owned and operated business provides exemplary service, short lead times, and the personalized attention that has made our name one of the most trusted in the industry.



851 Hemlock Road · P.O. Box 499
Morgantown, PA 19543
610-286-8884 | www.Viwinco.com



NC100 Updated © 5/2021 Viwinco Inc.

